

CARTIZAN®

深圳路知音科技有限公司
Shenzhen Cartizan Tech. Co., Ltd
Cartizan Corporation Limited

CARTIZAN®

深圳路知音科技有限公司
Shenzhen Cartizan Tech. Co., Ltd
Cartizan Corporation Limited

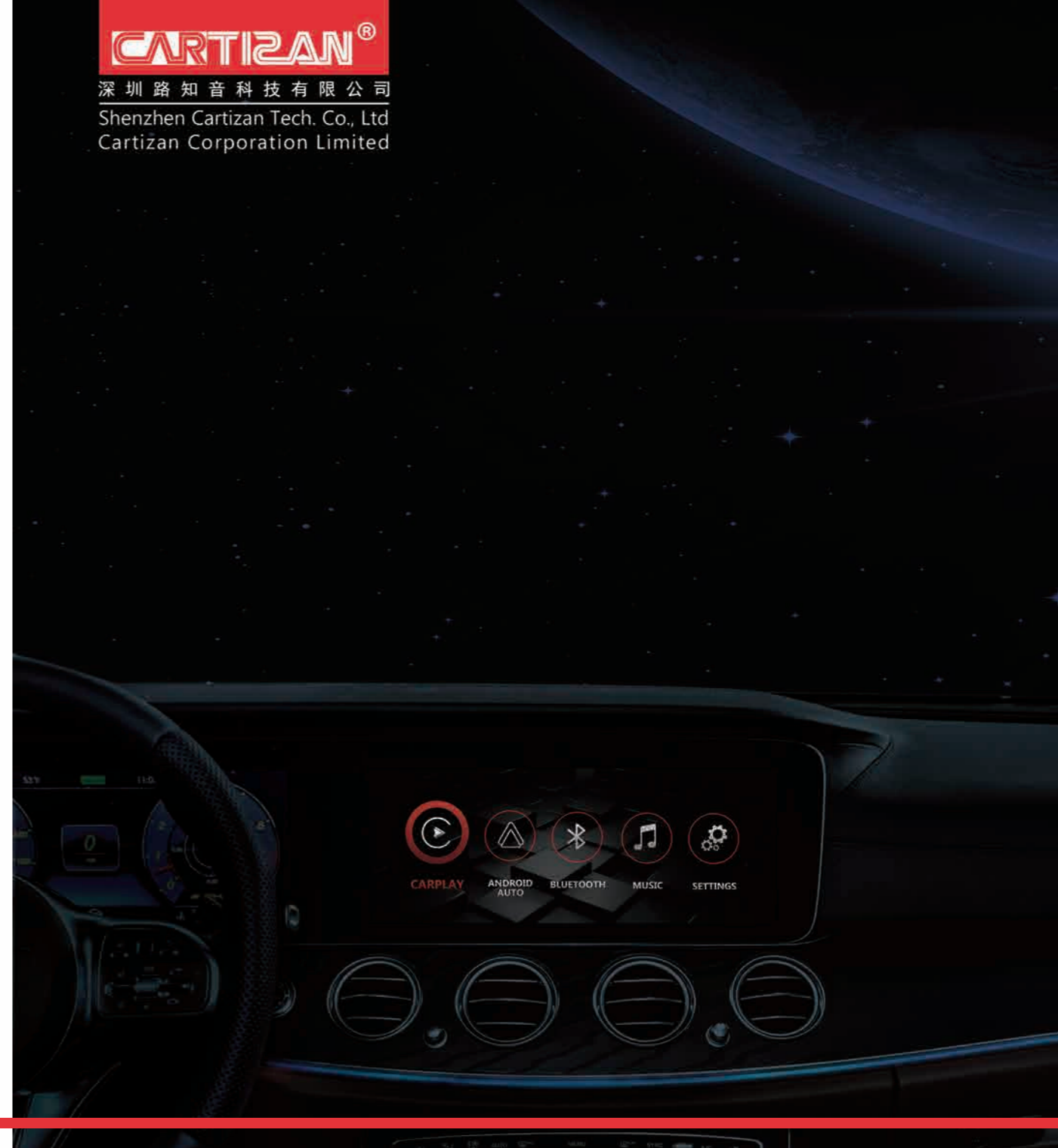

Tel: +86 755-2788 8592

Fax: +86 755-2936 1235

Email: sales@icartizan.com

Web: www.icartizan.com

Address: 6th Floor, Boshen Tech Building, Changxing North Road,
Longgang District, Shenzhen, China



**TOTAL SOLUTION FOR
CAR AUDIO & VIDEO INTERFACE**

CONTENT

- CARPLAY / ANDROID AUTO SOLUTIONS
 - UNIVERSAL WIRELESS SOLUTION
 - WIRELESS OEM INTEGRATION
 - FOR AFTERMARKET STEREO
- SCREEN MIRRORING
- CAMERA INTERFACE
- VIDEO SWITCHERS
- AUX-USB ADAPTER
- PICASOU ADAPTER

ABOUT CARTIZAN

Found in 2009, Cartizan Co., Ltd supplies oversea clients with seamless car audio and video integration system for OEM infotainment, which enable to gain the extra audio and video input on factory radio, just as CarPlay, Android Auto, screen mirroring, front and rear view camera, IPAS (Intelligent Parking Assistant System), digital TV, navigation, multimedia playback, etc.

More and more selected car brands are available, like Mercedes-Benz, BMW, Audi, Volkswagen, Porsche, Land Rover, Peugeot, Citroen, Volvo, Fiat, Ford, Lexus, Toyota, Honda and Nissan, etc.

Thanks for the clients and installer's trust and love of CARTIZAN interface, we are looking for strategic partners worldwide to develop customized products and jointly explore local markets, providing fantastic car audio & video experience and prompt customer service for local end users.

Welcome to join Cartizan distributor networks !

WELCOME TO JOIN US!



- CONFIRMED CARTIZAN AGENT
- IN DISCUSSIONS

WIRELESS UNIVERSAL CARPLAY/ANDROID AUTO

DESIGN FOR OEM & AFTERMARKET RADIO

- Built in wireless and wired Apple CarPlay & Android Auto
- HD multimedia playback via USB flash drive
- Integrate Bluetooth module for Android Auto calling audio delivering
- Support 2 CVBS video input (rear camera & video)
- Offer high performance microphone for phone talking & voice command
- Mobile phone charging
- Further software update via USB port
- HDMI Input (optional)



USB Media
Playback



Further SW.
Update



MODEL: CP-11
CVBS & HDMI OUTPUT



Fits any monitor with CVBS/HDMI input and operated by external knob controller



Display supporting all HDMI / CVBS signals



EXTERNAL TOUCH SCREEN

KNOB CONTROL

MODEL: CP-12

ANALOG RGB (VGA) OUTPUT

Major interfaces of the three countries

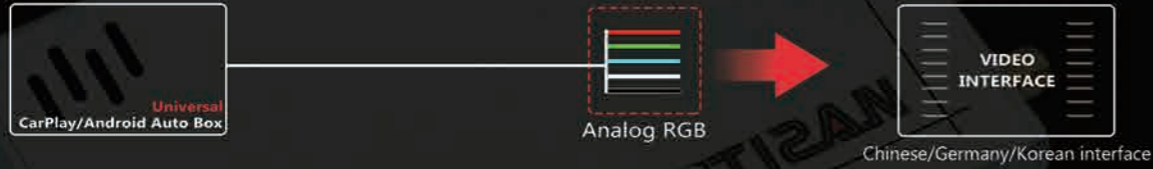

| CP-12 | | |
|--|-----------------------|-----------------------|
| Compatible with Chinese/Germany/Korean interface | | |
| MERCEDES-BENZ NTG 5.0 | MERCEDES-BENZ NTG 5.5 | MERCEDES-BENZ NTG 6.0 |
| BMW CIC | BMW NBT | BMW NBT-EVO |
| BMW MGU | AUDI MMI 3G | AUDI MIB 2 STD |
| AUDI SYMPHONY & CONCERT | PORSCHE PCM 3.1 | PORSCHE PCM 5.0 |
| PEUGEOT/CITROEN NAC | 2016-LAND ROVER 8" | 2016-LAND ROVER 10.2" |



FACTORY BUTTONS CONTROL

OEM TOUCH SCREEN CONTROL

WIRELESS CARPLAY/ ANDROID AUTO INTEGRATION

- Integrate wireless/wired phonelink including Apple CarPlay, Android Auto and screen mirroring functions
- USB HD video and lossless music playback (APE, WAV, FLAC, MP3, WMA, etc.)
- Offer 2 CVBS video input (front & rear view camera)
- Support PDC (Parking Distance Control) and FPG (Flexible Parking Guidelines)
- Supply 12V power to the backup camera
- Support clearer AHD cameras (optional)
- Integrated DSP module offers high quality audio effect (optional)
- Operate by OEM knob controller & steering wheel buttons
- Support both OEM and add on microphone
- Further software update via USB port
- Support TV tuner control on OEM radio (optional)



Screen
Mirroring



USB Media
Playback



F/R View
Cameras



FPG



PDC



Further SW.
Update



MULTI-FUNCTION

CARPLAY

ANDROID AUTO

MIRRORING

COMPATIBILITY

| MAKE | MODELS | YEARS | OEM SYSTEM |
|------------------------------|---|-----------|---|
| Mercedes -Benz | A/B/C/E/CLA/CLS/GLA/ GLK/ML | 2010-2014 | 5.8 / 7 inch monitor Comand NTG 4.5/4.7 system |
| | A/B/C/E/V/ML/CLA/CLS/ GLC/GLE/GLS | 2015- | 7.4 / 8.4 inch monitor Comand NTG 5.0/5.1/5.2 system |
| BMW | 1-7 series, X1/X3/X4/X5/X6 Mini Cooper | 2008-2012 | 6.5 / 8.8 inch OEM monitor CIC system |
| | 1-7 series, X1/X3/X4/X5 Mini | 2013-2016 | 6.5 / 8.8 / 10.25 inch OEM monitor NBT iDrive system and NBT-EVO ID4 |
| | 1-7 series, X1/X3/X4 | 2017- | 6.5 / 8.8 / 10.25 inch OEM monitor NBT-EVO ID 5 & ID 6 system |
| Audi | A3/A4/A5/A6/A7/A8/ Q3/Q5/Q7 | 2009- | MMI 3G system 7 inch OEM monitor |
| | A4/A5/Q5 | 2009-2016 | Without MMI Audi Symphony & Concert system |
| | A4/A5/Q5/Q7 | 2016- | MIB/MIB 2 STD 5.8 / 7 / 8.3 inch OEM monitor |
| Volkswagen | Golf, Passat, Polo, Tiguan, Magotan, Jetta, Beetle, Fox, etc. | 2016- | MIB 2 system with 5.8 / 6.5 / 8 inch OEM monitor and CD player in the glove compartment |
| Porsche | Cayenne, Macan | 2016- | PCM 4.0 system |
| Peugeot / Citroen | 308,3008,4008,C6, C3, C4,C5 | 2014-2018 | SMEG and NAC system |
| Toyota | Pioneer/Panasonic/Fujitsu head unit | 2014- | 60PIN/80PIN/96PIN FPC |
| Lexus | NX, ES, UX, IS,CT,RX, GS, LS | 2012- | 7 / 8 / 10.3 / 12.3 inch OEM monitor |

7 HIGHLIGHT

OF CARTIZAN CARPLAY INTEGRATION

1

SEAMLESS OPERATION AS ORIGINAL

Cartizan interface manages to simulate the operation of the original car (steering wheel control, OEM touch screen, OEM knob control, etc.) as much as possible to offer end-user an infinitely close OEM operating experience.



2

OEM MICROPHONE VOICE COMMAND CONTROL

No installation for aftermarket mic(if car with OEM mic). Better phone talking and voice command.

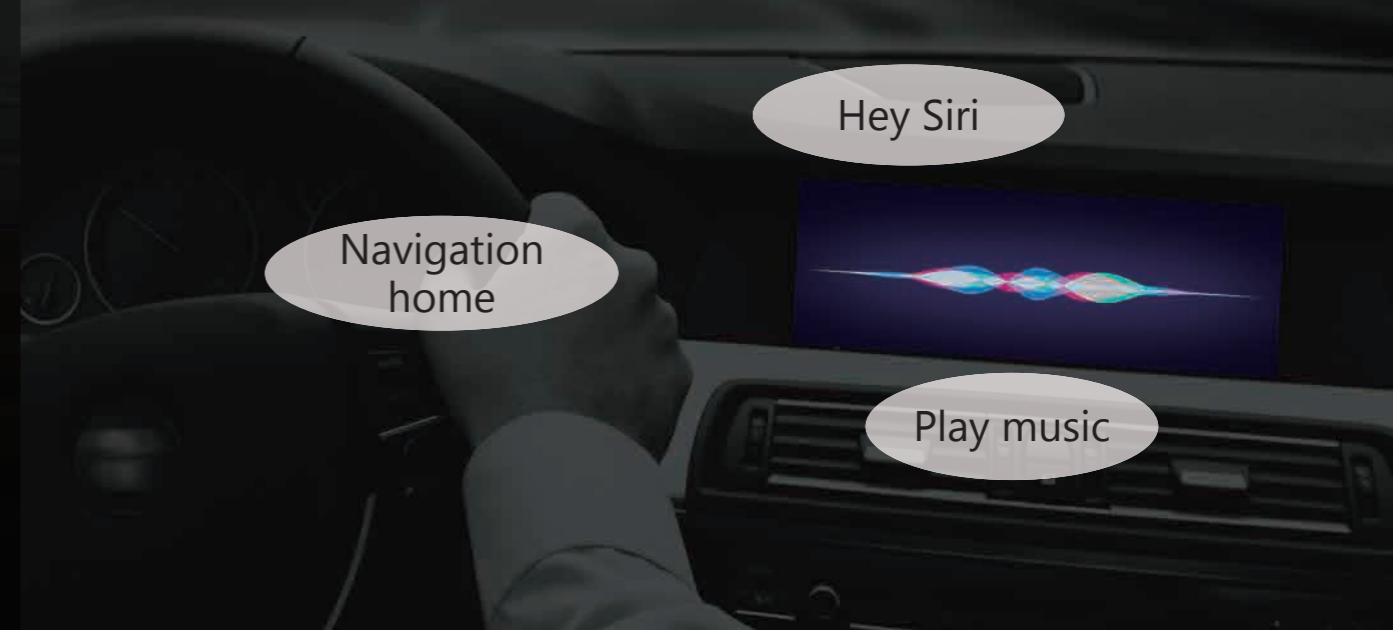

3 HD LVDS SIGNAL

Enjoy the same high-definition display as the original car screen resolution



4 SUPPORT AHD CAMERA INPUT (OPTIONAL)

Support high-definition camera input for clearer front and rear view



5 INTEGRATED DSP MODULE OFFERS HI-FI AUDIO EFFECT (OPTIONAL)

Treble, alto and bass could be adjusted to enjoy more real music



6 BUILT IN CAN-BUS READER FOR FAST PROBLEM SHOT

Simple and fast way to solve compatibility problems of different car models, no need for engineers to get canbus on site



7 OEM USB PLUG AND PLAY (OPTIONAL)

Hidden design and OEM USB plug & play, let it be more like original style



CARPLAY/ANDROID AUTO/ MIRRORING 3 IN 1 USB DONGLE FOR AFTERMARKET ANDROID/WINCE HEAD UNIT

- Easily switch as you like on CarPlay/Android Auto/Mirroring function
- The App runs automatically once the phone connected
- Support both left and right-hand drive CarPlay layout
- Available to change different car brands logo
- One-step online update or simple update via USB port
- Support both wired and wireless mode

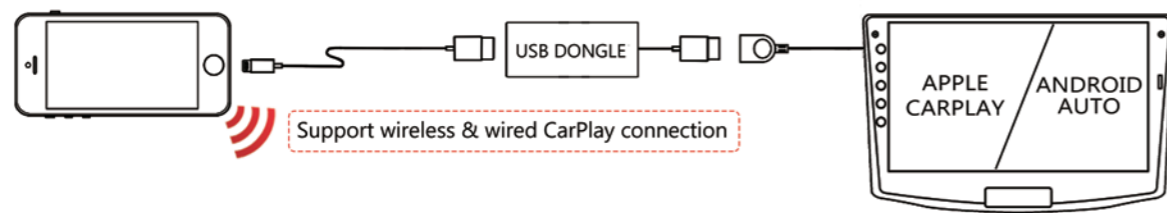

SCREEN MIRRORING ADAPTER

IOS AIRPLAY & ANDROID MIRACAST

ML-260

- Support latest iOS and Android OS
- Dual band: 5 GHz and 2.4 GHz
- Support wired and wireless mirroring
- HDMI and CVBS output
- HD multimedia playback via USB flash drive
- Input Power: 5.5V-36V DC
- External audio & video input (optional)



ML-280

- Support latest iOS and Android OS
- Wired mirroring mode, USB plug and play
- HDMI and CVBS output
- Support phone charging
- Fast update via USB port
- Integrate BT for Android phone audio delivering (optional)





FRONT & REAR CAMERA INTERFACE

Adjustable position of dynamic parking guideline 

Display front view for 10S after shifted from R gear 

F / R view camera + FPG + PDC   

HDMI / AV input (optional)  

TV / DVD control on steering wheel (optional) 

Add on CarPlay and Android Auto adapter (optional)

COMPATIBILITY

| MAKE | MODELS | YEARS | OEM SYSTEM |
|---------------------------|--|-----------|---|
| BMW | 3 series, 5 series, 6 series, 7 series, X1/X3/X5/X6/ | 2008-2012 | 6.5 / 8.8 / 10.25 inch OEM monitor CIC system |
| | 1-7 series, X1/X3/X4/X5, Mini | 2013-2016 | 6.5 / 8.8 / 10.25 inch OEM monitor NBT iDrive system |
| | 1-7 series, X1/X3/X4 | 2017- | 6.5 / 8.8 / 10.25 /12.3 inch OEM monitor NBT-EVO iDrive system |
| | 3 series, X5/X7 | 2018- | 12.3 inch OEM monitor MGU system |
| Mercedes -Benz | A/B/C/E/CLA/CLS/GLA/GLK/ML/cclass | 2010-2014 | 5.8 / 7 inch monitor Comand NTG 4.5/4.7 system |
| | A/B/C/E/V/ML/CLA/CLS/ GLC/ GLE/GLS class | 2015- | 7.4 / 8.4 inch monitor Comand NTG 5.0/5.1 system |
| | C/E/S class | 2018- | 12.3 inch monitor Comand NTG 5.5 system |
| | A class | 2018- | 7 / 10.25 inch MBUX system |
| Volkswagen | Golf, Passat, Polo, Tiguan, Magotan, Jetta, Beetle, Fox, etc. | 2016- | MIB 2 main unit CD player in the glove compartment |
| Seat | Alhabra, Altea, Leon, etc. | 2016- | |
| Skoda | Octavia, Superb, etc. | 2016- | |
| Porsche | Cayenne, Macan | 2012- | PCM 3.1 system |
| | Cayenne, Macan | 2016- | PCM 4.0/4.1 system |
| | Cayenne, Macan | 2018- | PCM 5.0 system, 12.3 inch monitor |
| Audi | A3/A4/A5/Q7 | 2017- | MMI 3G, MIB2, MIB2P, SYMPHONY/ CONCERT system STD, 7 / 8.3 inch monitor |
| Land Rover | Range Rover/Sport, Evoque, Discovery/Sport, etc. | 2016- | 8 / 10.2 inch monitor, Harman system |
| | Velar, Discovery Sport, Range Rover | 2018- | dual screen |
| Ford | Edge, Escape, F-150, Fiesta, Focus, Explorer, Fusion; Mustang; Lincoln MKZ, MKX, etc. vehicles with SYNC 3 system | 2016- | SYNC 3 system |
| Peugeot | 308, 3008, 4008 | 2017- | 7 / 8 inch capacitive monitor NAC system |
| Citroen | C3, C4, C5, C6 | | |



4 TO 1 CVBS VIDEO SWITCHER

INTELLIGENT CAMERAS SWITCH SYSTEM

- 4 cameras video input, 1 video output
- 2 ways to activate camera: auto trigger by car lights or wireless remote controller
- Display front view 10S automatically after shifted from R gear
- Integrated power filter offers pure 12V for cameras

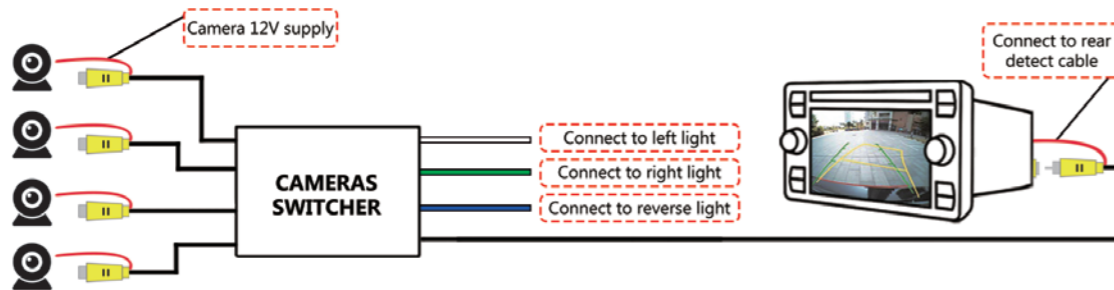

External wireless remote controller



Display front view for 10 seconds automatically after shifted from R gear

1 TO 3 CVBS VIDEO SPLITTER

1 RCA VIDEO INPUT & 3 RCA VIDEO OUTPUT

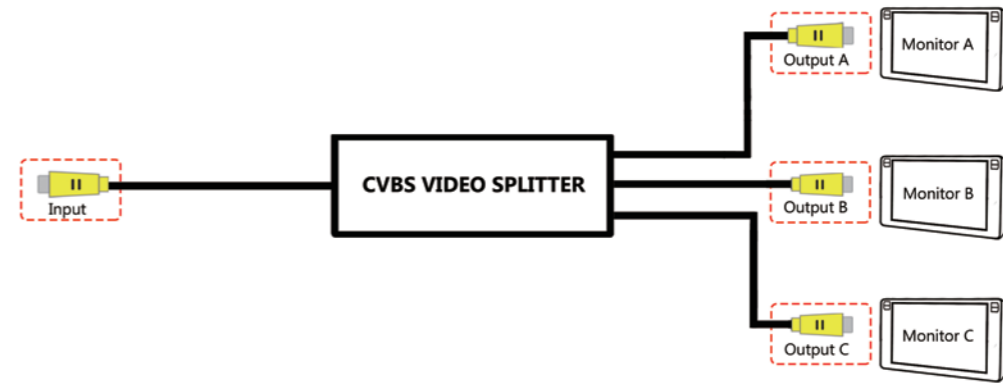

2 TO 1 CVBS VIDEO SWITCHER

2 RCA VIDEO INPUT & 1 RCA VIDEO OUTPUT

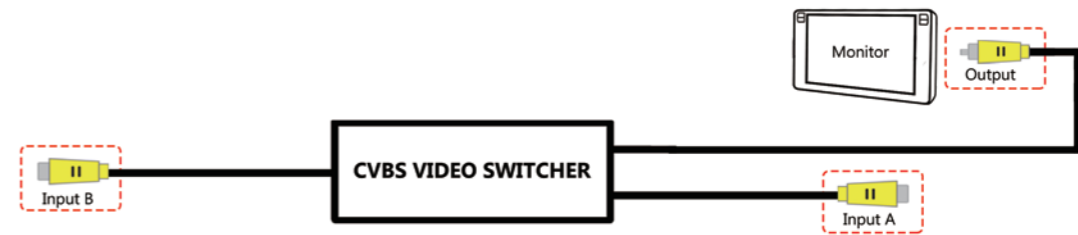

2 TO 1 AUDIO & VIDEO SWITCHER

2 RCA A/V INPUT & 1 RCA A/V OUTPUT

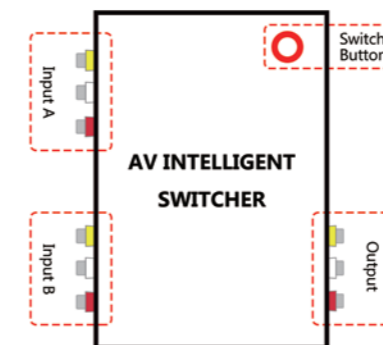

AUX-USB AUDIO ADAPTER

SPECIAL DESIGN FOR CAR WITHOUT OEM AUX FUNCTION

- Streaming external audio to OEM stereo via factory USB port
- Support software update for updated car models
- Plug and play installation



COMPATIBILITY

| MAKE | MODELS | YEARS |
|----------------------|--|-------|
| AUDI | A1/A2/A3/A4/A5/A6/A7/A8/Q5/Q7 | 2018- |
| BMW | 1/2/3/4/5/7 series, X3/X4/X6, NBT-EVO ID5 & ID6, MGU ID7 | 2017- |
| Cadillac | ATSL-25T, XTS-28T, ATSC-28T, XT5-25T, CT6-28T | 2018- |
| Chevrolet | Onix/Prisma/Tracker | 2018- |
| Citroen | C3,C4,C5,C6 | 2017- |
| Ferrari | 488 GTB | 2018- |
| Fiat | Vehicles without AUX port | 2018- |
| Ford | Vehicles with SYNC 3 (Support Asian version only) | 2016- |
| Honda | Accord 10th Gen. | 2017- |
| Jaguar | XE, XF, XJ, XEL, XJL, XK, F-PACE | 2017- |
| Land Rover | Discovery Sport, Freelander, Evoque, Velar | 2017- |
| Mercedes-Benz | A/B/C/E/S/V/CLA/GLA/GLC/GLE/GLS class NTG 5.0 / 5.1 / 5.2 / 5.5 / 6.0 MBUX system | 2014- |
| Nissan | Sentra,Patrol | 2016- |
| Peugeot | 208, 2008, 3008, 4008, 5008 | 2017- |
| porsche | Macan,Cayenne; PCM 3.1 / 4.0 / 5.0 | 2017- |
| Renault | Kwid, Captur, Duster Oroch, Duster, Fluence, Stepway, Sandero, Logan | 2018- |
| Volvo | 2016- XC90/S90/XC60, 9" monitor | 2016- |

* Compatible list is continuously updated. please contact our sales for the latest news.

NEW PROJECT

PICASOU™

**THE NEXT
REVOLUTION**
FOR OEM CAR INFOTAINMENT SYSTEM

PICASOU™ ADAPTER

PLUG IN CAR ANDROID SYSTEM VIA ORIGINAL USB

Design for OEM radio with Android Auto or CarPlay

- USB plug and play without removing OEM radio
- Base on Android 7.1 Nougat system
- Install your favorite Apps like YouTube, Facebook, Google search, online navigation & radio, etc
- Integrate GPS module for accurate navigation
- Operate by factory touch screen
- External touchpad can be selected for a car without touch screen
- High-quality audio delivering with OEM speakers
- Integrate HDMI input and output
- Rear camera input (optional)

