

Horizontal Detailed Drawings of Terracotta Louver

设计 DESIGNED BY	审核 REVISIONS	图号 DRAWING NO.	TG-01	工程名称 PROJECT	
校对 CHECKED BY	日期 DATE	2019.07.23	比例 SCALE	1:1	图名 DRAWING TITLE

陶板横节点图

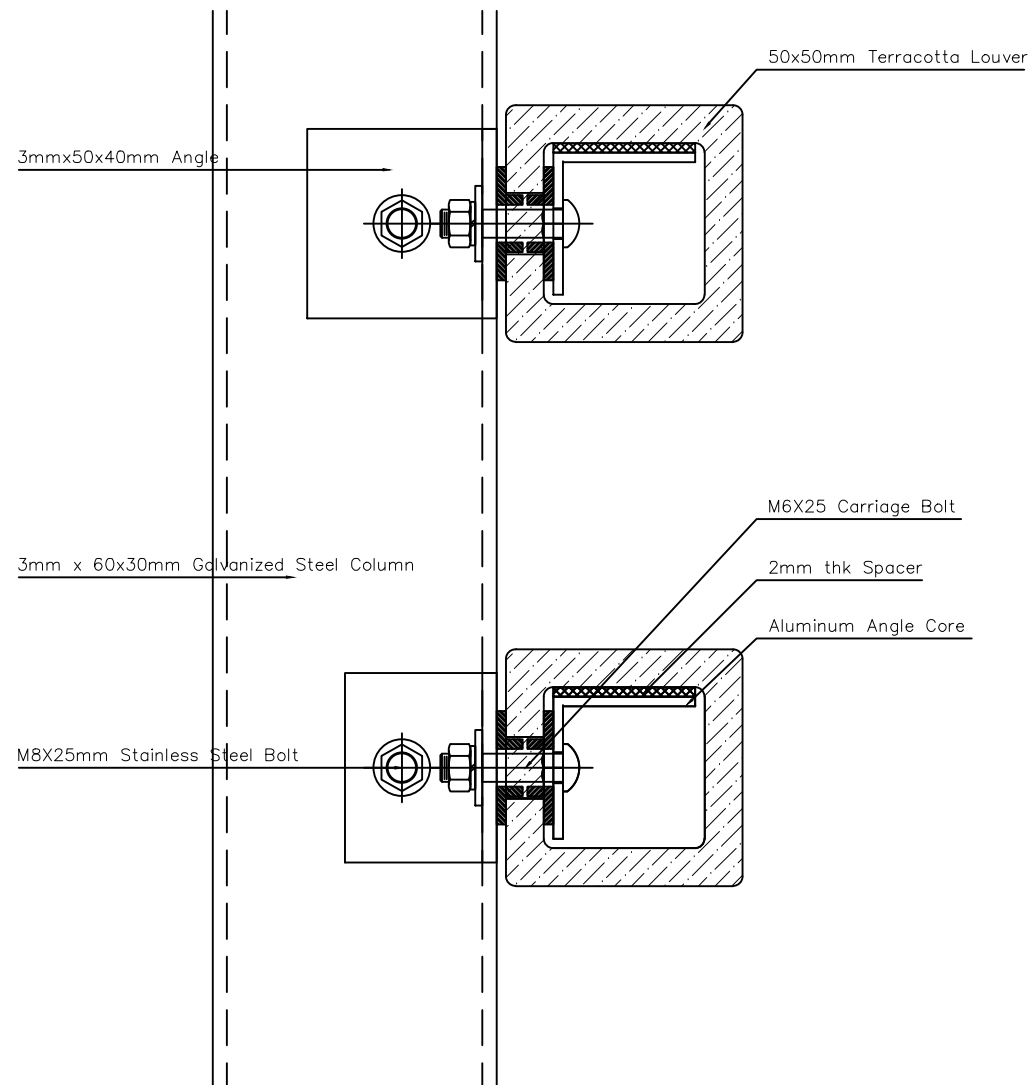

Vertical Detailed Drawings of Terracotta Louver

设计 DESIGNED BY	审核 REVISIONS	图号 DRAWING NO.	TG-02	工程名称 PROJECT	
校对 CHECKED BY	日期 DATE	2019.07.23	比例 SCALE	1:1	图名 DRAWING TITLE
					陶板竖向节点图

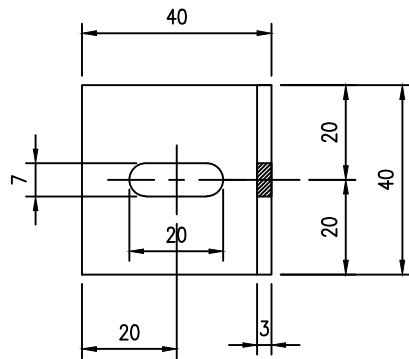
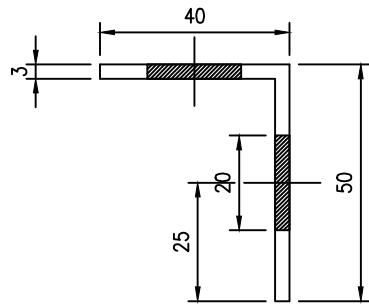

50x40x3
Aluminum Angle

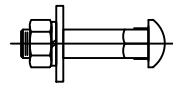

M6X25 Carriage Bolt

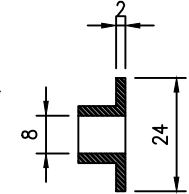
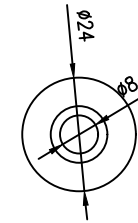
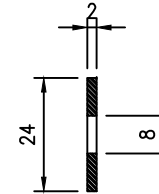
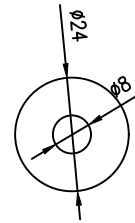

2mm Gasket I

2mm Gasket II

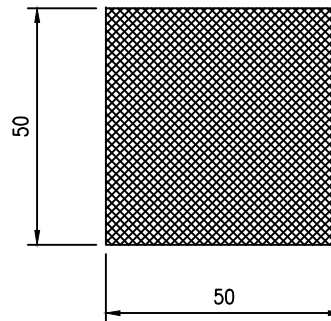

2mm Spacer

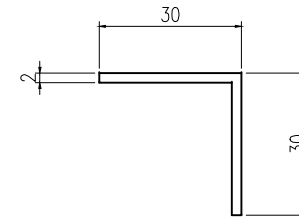

Aluminum Angle Core

设计 DESIGNED BY	审核 REVISIONS	图号 DRAWING NO.	TGPJ-01	工程名称 PROJECT	
校对 CHECKED BY	日期 DATE	2019.07.23	比例 SCALE	1:1	图名 DRAWING TITLE
					陶板配件加工图