



**QUALITY**  
**COMES FIRST**  
CUSTOMER IS SUPREME

Yako Hardware Manufacturer Co.,Ltd  
Add: No.898 Middle Jiangmen Avenue Industrial Park, Jiangmen,  
Guangdong,China.  
Post Code:529000  
Tel:+86 750 3278683  
Webpage: [www.yako-hw.com](http://www.yako-hw.com)  
Email: [sales01@yako-hw.com](mailto:sales01@yako-hw.com)



# YAKO HARDWARE



**YAKO HARDWARE  
MANUFACTURER CO., LTD**



# YAKO OUR CERTIFICATE



# ABOUT YAKO

Yako Hardware Manufacturer Co., Ltd is a professional manufacturer in producing architectural hardware products, including the products for doors, windows, furniture, glass, bathroom, kitchenware, stairs and outdoor since 2003. Our main scope is handles, hinges, locks and other accessories for doors.

Covering an area of 6,000 square meters, owning 10 production lines and nearly 200 workers, Yako could offer over 3,000 solutions for architectural projects and interior designs. All of our products are regularly reviewed to ensure the widest range for providing our customers with one-station purchase. We improve the quality control process and confirm prices according to current cost of raw materials in the market to make sure our customers always get the most reasonable deal.

We have accumulated experience and knowledge on how to make our customers satisfied besides product quality. We understand that a responsible after-sales service means the best help and treatment for our customers and we are always proud to have been recognized by our customers in this aspect.

Adhering to "Quality comes first, Customer is supreme", we are more willing to offer competitive prices and samples upon receiving your inquiry. We believe that our high-quality products and excellent customer service will meet your requirements.

# CERTIFICATES

We are focusing on products professionalism to provide our customers best service and quality.





# Door Handle

## Tubular Lever Handle

 <b>YFK-001</b>	 <b>YFK-002</b>	 <b>YFK-003</b>	 <b>YFK-004</b>
 <b>YFK-005</b>	 <b>YFK-006</b>	 <b>YFK-007</b>	 <b>YFK-008</b>
 <b>YFK-009</b>	 <b>YTH-101</b>	 <b>YTH-102</b>	 <b>YTH-103</b>
 <b>YTH-104+YFK-007</b>	 <b>YTH-105</b>	 <b>YTH-106</b>	 <b>YTH-107</b>
 <b>YTH-108</b>	 <b>YTH-109</b>	 <b>YTH-110</b>	 <b>YTH-111</b>

### ▶ Insert Materials



Iron Brass Aluminum Stainless Steel



Door Handle

**Tubular Lever Handle**



**Solid Lever Handle**



**Solid Lever Handle**



Door Handle























**Door Handle**

**Solid Lever Handle**

 <b>YLH-029</b>	 <b>YLH-030</b>	 <b>YLH-031</b>	 <b>YLH-032</b>
 <b>YLH-033</b>	 <b>YLH-034</b>	 <b>YLH-035</b>	 <b>YLH-036</b>
 <b>YLH-038</b>	 <b>YLH-039</b>	 <b>YLH-040</b>	 <b>YLH-041</b>
 <b>YLH-042</b>	 <b>YLH-044</b>	 <b>YLH-045</b>	 <b>YLH-046</b>
 <b>YLH-047</b>	 <b>YLH-048</b>	 <b>YLH-049</b>	 <b>YLH-050</b>

**Solid Lever Handle**

 <b>YLH-051</b>	 <b>YLH-052</b>	 <b>YLH-053</b>	 <b>YLH-054</b>
 <b>YLH-055</b>	 <b>YLH-056</b>	 <b>YLH-057</b>	 <b>YLH-119</b>
 <b>YLH-121</b>	 <b>YLH-122</b>	 <b>YLH-123</b>	 <b>YLH-124</b>
 <b>YLH-125</b>	 <b>YLH-126</b>	 <b>YLH-127</b>	 <b>YLH-128</b>
 <b>YLH-129</b>	 <b>YLH-230</b>	 <b>YLH-130</b>	 <b>YLH-131</b>

**Door Handle**



Door Handle

**Magnetic Handle**



**Aluminum Handle**



**Aluminum Handle**



Door Handle



Door Handle

Aluminum Handle



Rosette, Escutcheon & Spindle

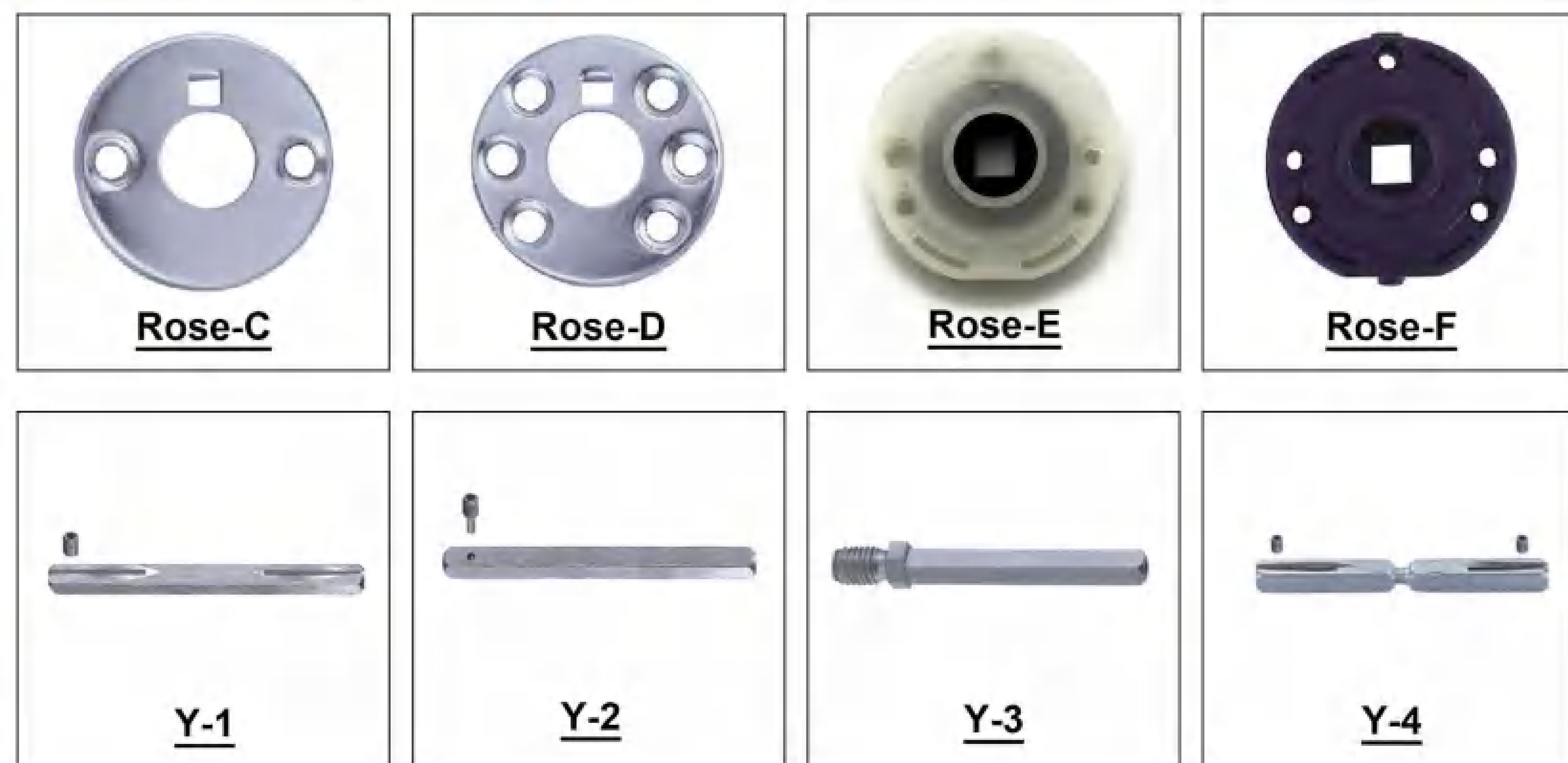

Rosette, Escutcheon & Spindle



Door Handle



Door Handle

**Cylinder**



**Mortise Lock**



Door Handle

**Mortise Lock**



**Handle on Plate**





Door Handle

**Handle on Plate**

 <b>YFH-134</b>	 <b>YLP-001</b>	 <b>YLP-002</b>	 <b>YLP-003</b>
 <b>YTP-201</b>	 <b>YTP-202</b>	 <b>YTP-203</b>	 <b>YTP-204</b>
 <b>YTP-205</b>	 <b>YTP-206</b>	 <b>YTP-207</b>	 <b>YTP-208</b>
 <b>YTP-209</b>	 <b>YTP-210</b>	 <b>YTP-211</b>	 <b>YTP-212</b>
 <b>YTP-213</b>	 <b>YTP-214</b>	 <b>YTP-216</b>	 <b>YTP-217</b>

**Handle on Plate**

 <b>YTP-218</b>	 <b>YTP-219</b>	 <b>YTP-220</b>	 <b>YTP-221</b>
 <b>YTP-222</b>	 <b>YTP-223</b>	 <b>YTP-224-B</b>	 <b>YTP-224</b>
 <b>YTP-225</b>	 <b>YTP-226</b>	 <b>YTP-227</b>	 <b>YTP-228</b>
 <b>YTP-229</b>	 <b>YTP-230</b>	 <b>YTP-231</b>	 <b>YTP-232</b>
 <b>YTP-232</b>	 <b>YTP-234</b>	 <b>YTP-235</b>	 <b>YTP-236</b>

Door Handle



Window Handle

Window Handle



Window Handle



Stainless Steel Furniture



Window Handle



Furniture Handle

**Stainless Steel Furniture**

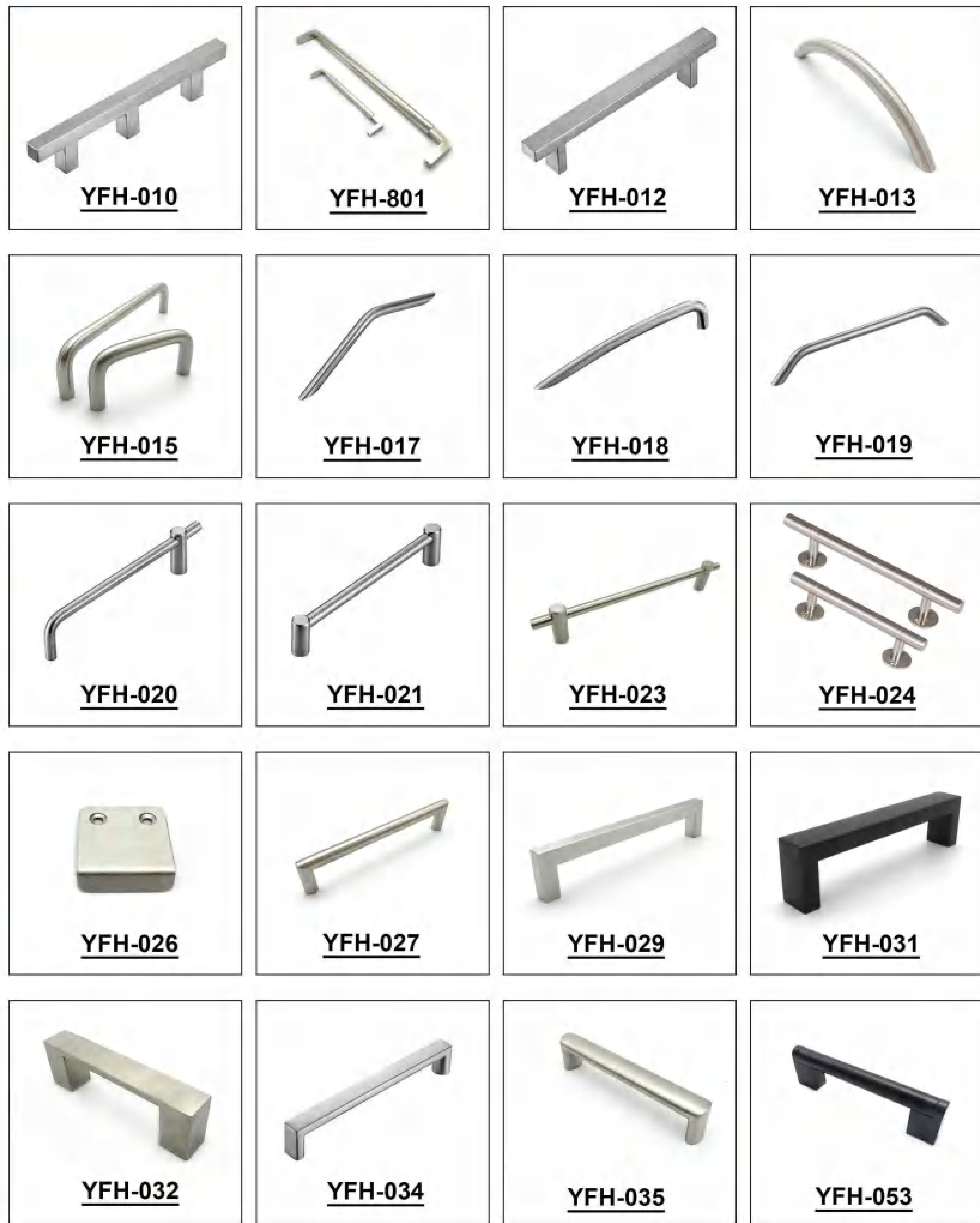

**Stainless Steel Furniture**



Furniture Handle



Furniture Handle

**Aluminum Alloy & Zinc Alloy Furniture Handle**

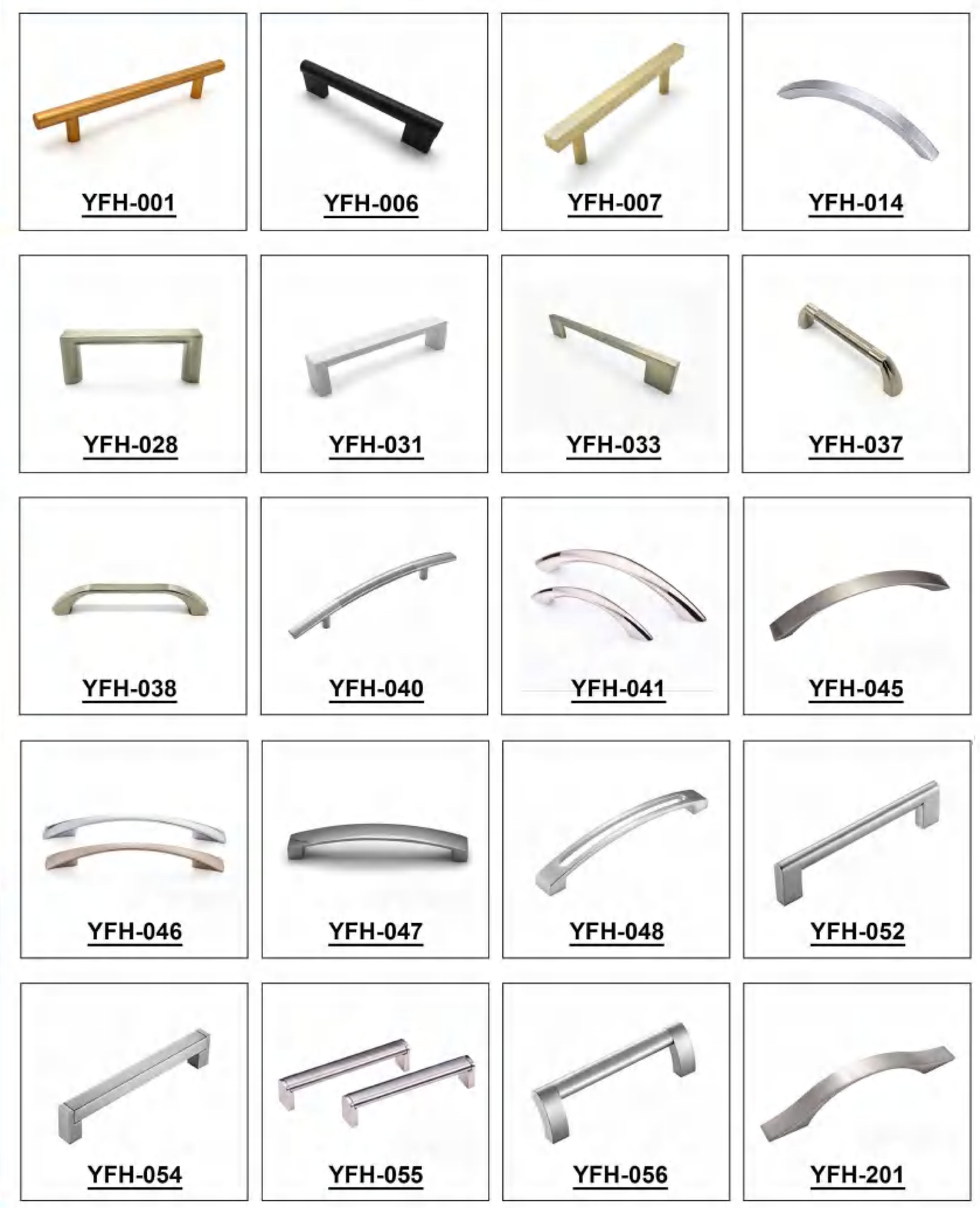

**Aluminum Alloy & Zinc Alloy Furniture**



Furniture Handle



Furniture Handle

**Aluminum Alloy & Zinc Alloy Furniture Handle**



**Aluminum Alloy & Zinc Alloy Furniture Handle**

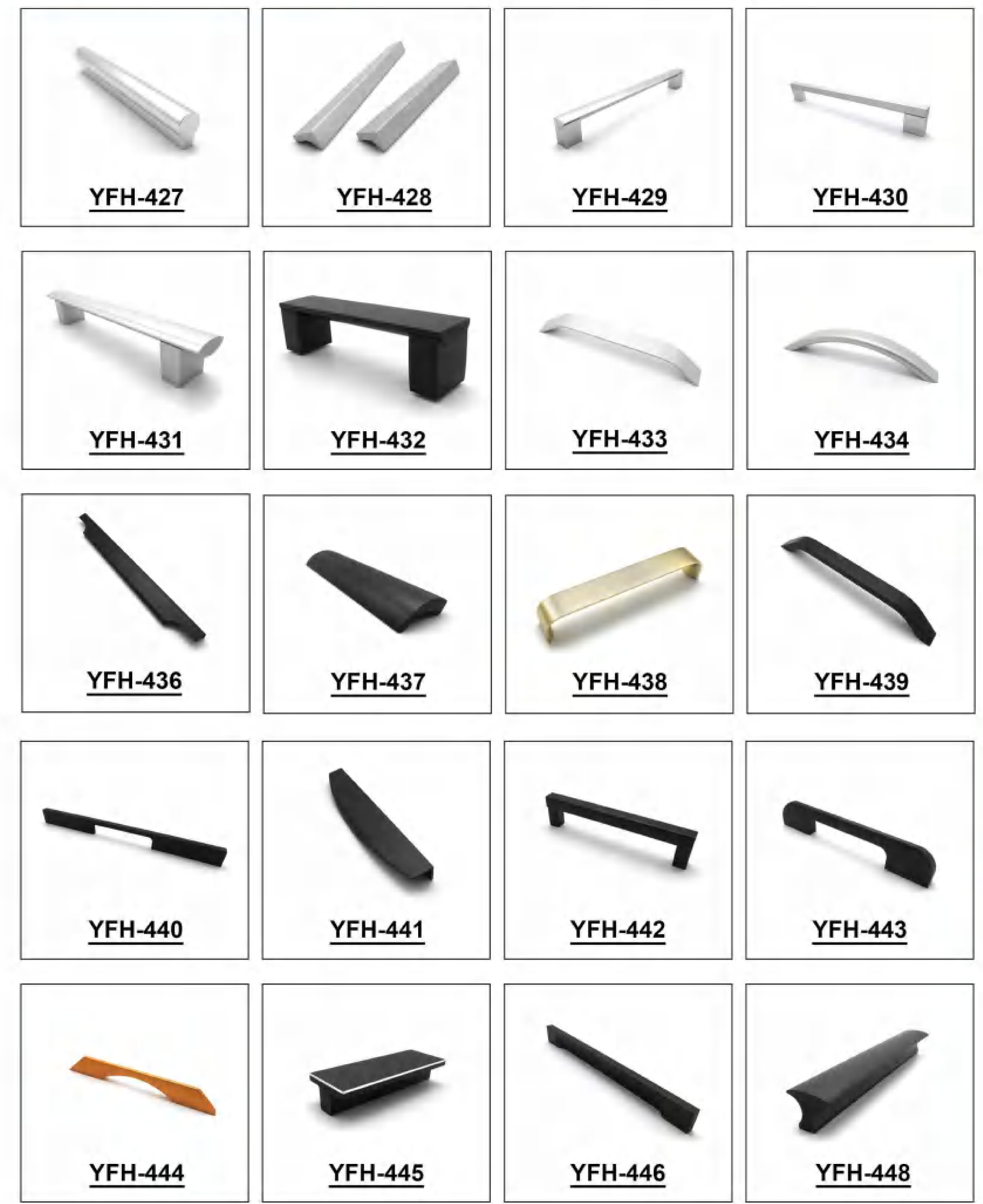

Furniture Handle



Furniture Handle

**Flush Pull**

 <u>YBC-011</u>	 <u>YBC-012</u>	 <u>YBC-013A</u>	 <u>YBC-013B</u>
 <u>YBC-014</u>	 <u>YBC-015</u>	 <u>YBC-016</u>	 <u>YBC-017</u>
 <u>YBC-021</u>	 <u>YBC-022R</u>	 <u>YBC-022S</u>	 <u>YFH-057</u>
 <u>YFH-058</u>	 <u>YFH-059</u>	 <u>YFH-060</u>	 <u>YFH-061</u>
 <u>YFH-062</u>	 <u>YFH-063</u>	 <u>YFH-064</u>	 <u>YFH-065</u>

**Flush Pull**

 <u>YFH-066</u>	 <u>YFH-067</u>	 <u>YFH-068</u>	 <u>YFH-069</u>
 <u>YFH-070</u>	 <u>YFH-071</u>	 <u>YFH-210</u>	 <u>YFH-318</u>
 <u>YFH-401</u>	 <u>YFH-402</u>	 <u>YFH-403</u>	 <u>YFH-404</u>
 <u>YFH-405</u>	 <u>YFH-406</u>	 <u>YFH-409</u>	 <u>YFH-423</u>
 <u>YFH-450</u>	 <u>YFH-451</u>	 <u>YFH-454</u>	 <u>YFH-455</u>

Furniture Handle



Furniture Handle

**Furniture Knob**

 <u>YFH-090</u>	 <u>YFH-091</u>	 <u>YFH-092</u>	 <u>YFH-093</u>
 <u>YFH-094</u>	 <u>YFH-095</u>	 <u>YFH-096</u>	 <u>YFH-097</u>
 <u>YFH-098</u>	 <u>YFH-099</u>	 <u>YFH-100</u>	 <u>YFH-101</u>
 <u>YFH-102</u>	 <u>YFH-103</u>	 <u>YFH-104</u>	 <u>YFH-105</u>
 <u>YFH-106</u>	 <u>YFH-107</u>	 <u>YFH-108</u>	 <u>YFH-109</u>

**Furniture Knob**

 <u>YFH-110</u>	 <u>YFH-111</u>	 <u>YFH-112</u>	 <u>YFH-113</u>
 <u>YFH-114</u>	 <u>YFH-115</u>	 <u>YFH-116</u>	 <u>YFH-117</u>
 <u>YFH-118</u>	 <u>YFH-119</u>	 <u>YFH-120</u>	 <u>YFH-121</u>
 <u>YFH-122</u>	 <u>YFH-123</u>	 <u>YFH-124</u>	 <u>YFH-125</u>
 <u>YFH-126</u>	 <u>YFH-127</u>	 <u>YFH-128</u>	 <u>YFH-129</u>

Furniture Handle



Door Hinge

**Furniture Knob**



# Door Hinge



**2 Ball Bearings Hinge**



**4 Ball Bearings Hinge**

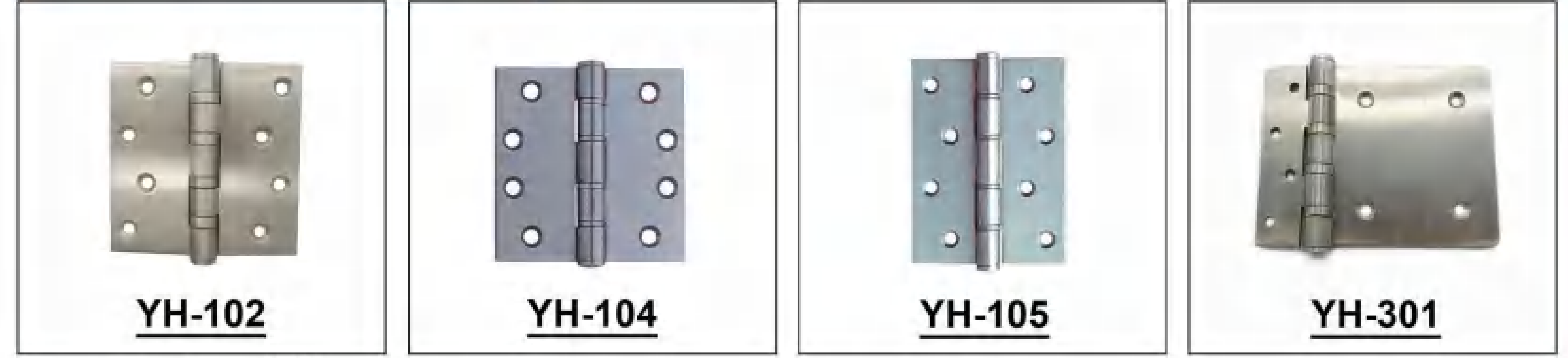

**Security Hinge**



**Window Hinge**

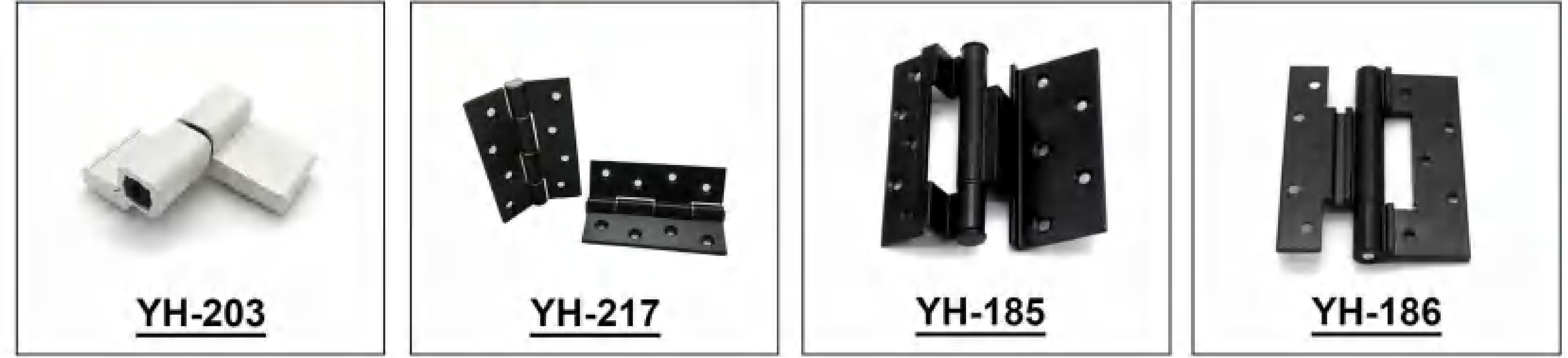

Door Hinge



Door Hinge

Door Hinge

**Butt Hinge**



**Flush Hinge**



**Cranked Hinge**



**Lift off Hinge**



**Flag Hinge**



**Self-Rising Hinge**





Door Hinge

Door Hinge

**Spring Hinge**

 <b>YH-124</b>	 <b>YH-125</b>	 <b>YH-126</b>	 <b>YH-164</b>
 <b>YH-165</b>	 <b>YH-166</b>	 <b>YH-173</b>	 <b>YH-188</b>
 <b>YH-200</b>	 <b>YH-201</b>	 <b>YH-206</b>	 <b>YH-301</b>
 <b>YH-302</b>	 <b>YH-324</b>	 <b>YH-325</b>	 <b>YH-328</b>

**Pivot Hinge**

 <b>YH-001</b>	 <b>YH-127</b>	 <b>YH-162</b>	 <b>YH-163</b>
--	--	---	--

**Pivot Hinge**

 <b>YH-166</b>	 <b>YH-168</b>	 <b>YH-169</b>	 <b>YH-170</b>
 <b>YH-171</b>	 <b>YH-172</b>	 <b>YH-175</b>	 <b>YH-178</b>
 <b>YH-179z</b>	 <b>YH-218</b>	 <b>YH-219</b>	 <b>YH-220</b>

**Concealed Hinge**

 <b>YZH-008</b>	 <b>YZH-009</b>	 <b>YZH-010</b>	 <b>YZH-011</b>
 <b>YZH-012</b>	 <b>YZH-013</b>	 <b>YZH-014</b>	 <b>YZH-015</b>



Door Hinge

**Concealed Hinge**



**Brass Hinge**



Door Hinge

**Brass Hinge**



**Piano Hinge**



**Iron Hinge**

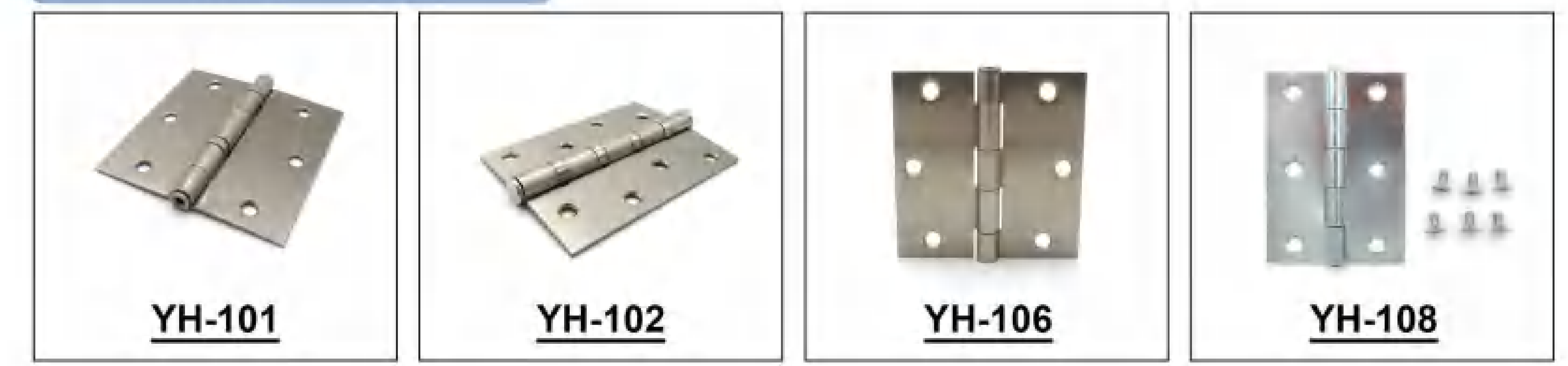



Door Hinge

**Iron Hinge**



**Jewelry Box Hinge**



**Jewelry Box Hinge**



**Industrial Hinge**

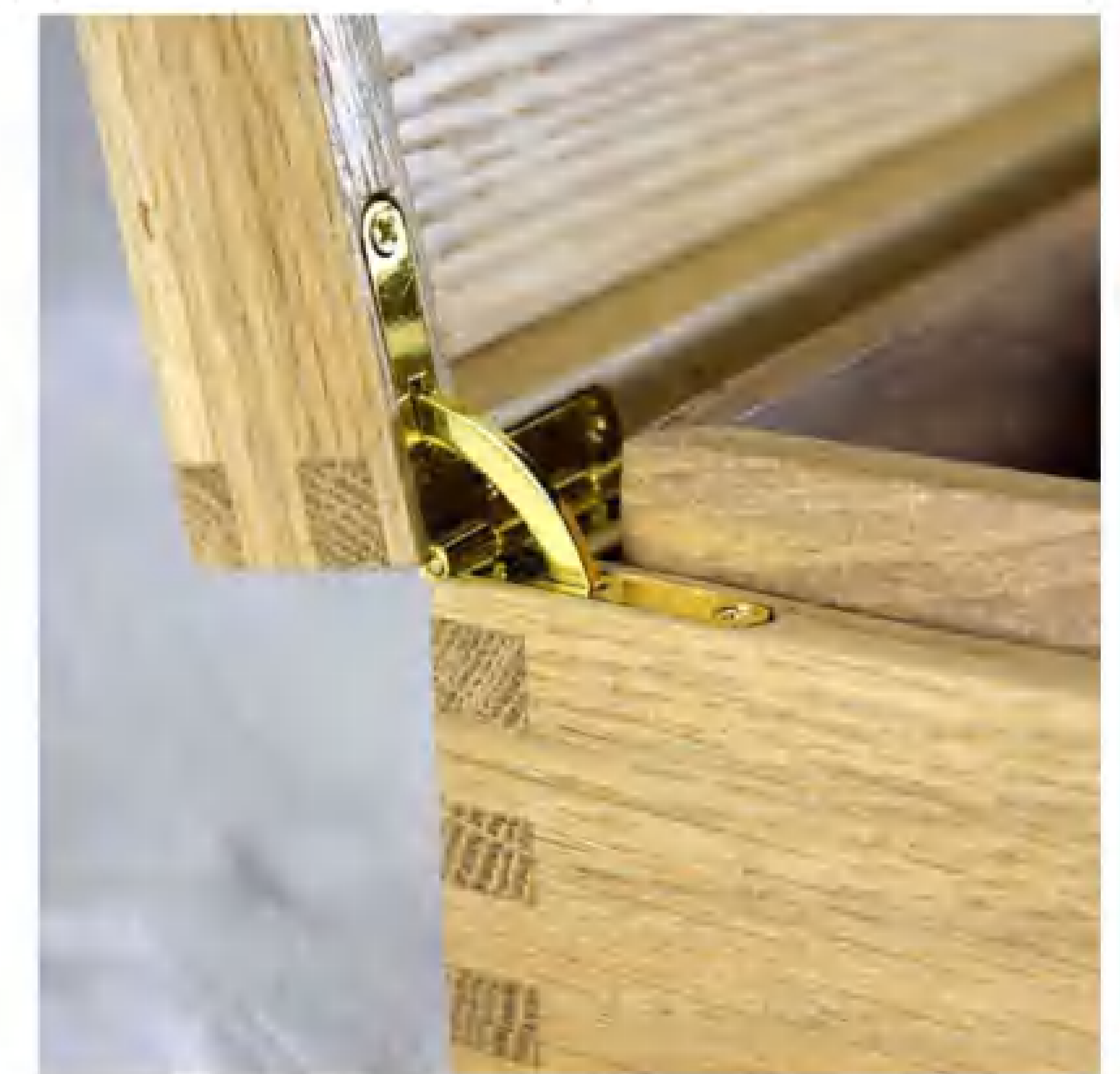

Door Hinge





# Door Lock

## Three Pole Knob Lock



YTL-001



YTL-002



YTL-003



YTL-004



YTL-005



YTL-020



YTL-021



YTL-022



YTL-037



YTL-044



YTL-045



YTL-046

## Three Pole Handle Lock



YTL-006



YTL-007



YTL-008



YTL-009



YTL-010



YTL-011



YTL-012



YTL-013

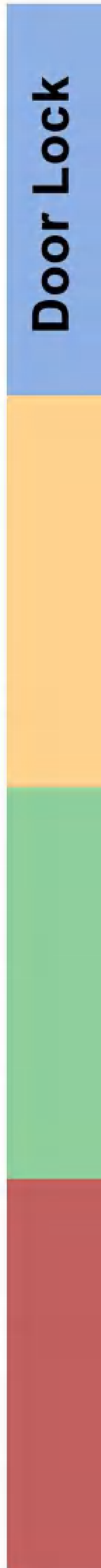

Door Lock



Door Lock

**Three Pole Handle Lock**



**Cylindrical Knob Lock**



Door Lock



Door Lock

Door Lock

**Cylindrical Knob Lock**



**Cylindrical Handle Lock**



**Deadbolt Lock**



**Deadbolt Lock**



**Rim Lock**



**Entrance Door Lock**



**Sliding Door Lock**



**Lock Latch**





Door Stopper



Door Stopper

**Door Stopper**

 <b>YDH-001</b>	 <b>YDH-002</b>	 <b>YDH-006</b>	 <b>YDH-007</b>
 <b>YDH-009</b>	 <b>YDH-010TR</b>	 <b>YDH-010</b>	 <b>YDH-011</b>
 <b>YDH-012</b>	 <b>YDH-013</b>	 <b>YDH-014</b>	 <b>YDH-015</b>
 <b>YDH-016</b>	 <b>YDH-017</b>	 <b>YDH-018</b>	 <b>YDH-019</b>
 <b>YDH-020AL</b>	 <b>YDH-020</b>	 <b>YDH-021</b>	 <b>YDH-022</b>



Door Stopper

**Door Stopper**



**Door Stopper**



Door Stopper













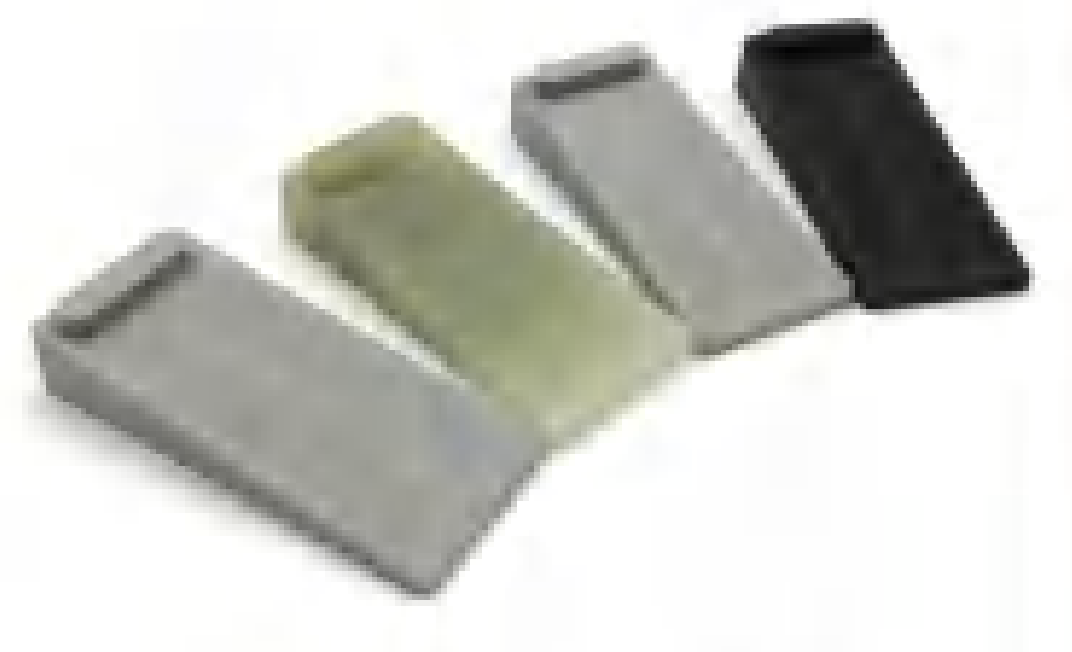
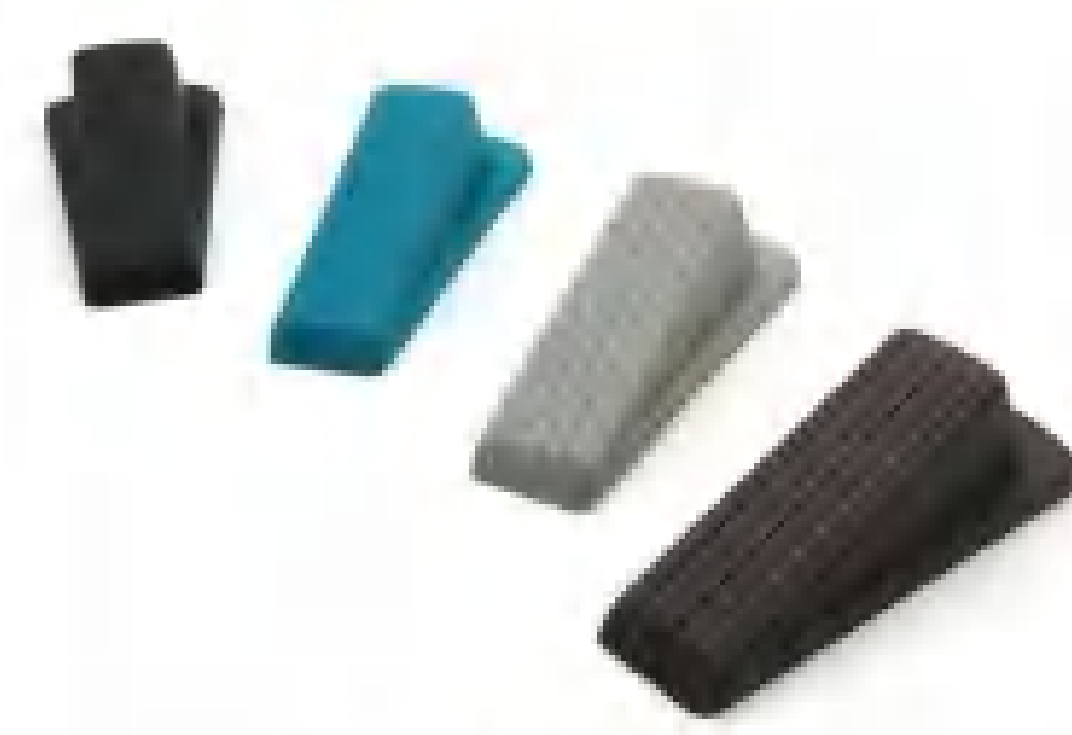







Door Stopper

**Door Stopper**

 <b>YDH-090</b>	 <b>YDH-091</b>	 <b>YDH-092</b>	 <b>YDH-093</b>
 <b>YDH-094</b>	 <b>YDH-095</b>	 <b>YDH-096</b>	 <b>YDH-097</b>
 <b>YDH-098</b>	 <b>YDH-099</b>	 <b>YDH-100</b>	 <b>YDH-101</b>
 <b>YDH-102L</b>	 <b>YDH-103</b>	 <b>YDH-104</b>	 <b>YDH-105</b>
 <b>YDH-106</b>	 <b>YDH-107</b>	 <b>YDH-108</b>	 <b>YDH-109</b>

**Door Stopper**

 <b>YDH-110</b>	 <b>YDH-111</b>	 <b>YDH-112</b>	 <b>YDH-113</b>
 <b>YDH-114</b>	 <b>YDH-115</b>	 <b>YDH-116</b>	 <b>YDH-117</b>
 <b>YDH-118</b>	 <b>YDH-119</b>	 <b>YDH-120</b>	 <b>YDH-121</b>
 <b>YDH-122</b>	 <b>YDH-123</b>	 <b>YDH-124</b>	 <b>YDH-125</b>
 <b>YDH-126</b>	 <b>YDS-101</b>	 <b>YDS-102</b>	 <b>YDS-103</b>

Door Stopper



Door Stopper

**Magnetic Door Stopper**

 <b>YMDS-001</b>	 <b>YMDS-003</b>	 <b>YMDS-005</b>	 <b>YMDS-013</b>
 <b>YMDS-023</b>	 <b>YMDS-025</b>	 <b>YMDS-026</b>	 <b>YMDS-027</b>
 <b>YMDS-028</b>	 <b>YMDS-029</b>	 <b>YMDS-030</b>	 <b>YMDS-031</b>
 <b>YMDS-032</b>	 <b>YMDS-033</b>	 <b>YMDS-034</b>	 <b>YMDS-035</b>
 <b>YMDS-036</b>	 <b>YMDS-037BL</b>	 <b>YMDS-037GP</b>	 <b>YMDS-038</b>

Door Bolt

**Magnetic Door Stopper**

 <b>YMDS-039</b>	 <b>YMDS-040</b>	 <b>YMDS-041</b>	 <b>YMDS-042</b>
--	--	--	--

**Door Bolt**



 <b>YDB-001</b>	 <b>YDB-002</b>	 <b>YDB-003</b>	 <b>YDB-004</b>
---	---	---	---



Door Bolt

**Door Bolt**



**Door Bolt**



Door Bolt



Door Bolt

**Door Bolt**



**Door Guard & Door Chain**



**Door Guard & Door Chain**



**Door Closer**



Door Closer



Door Closer

**Door Closer**

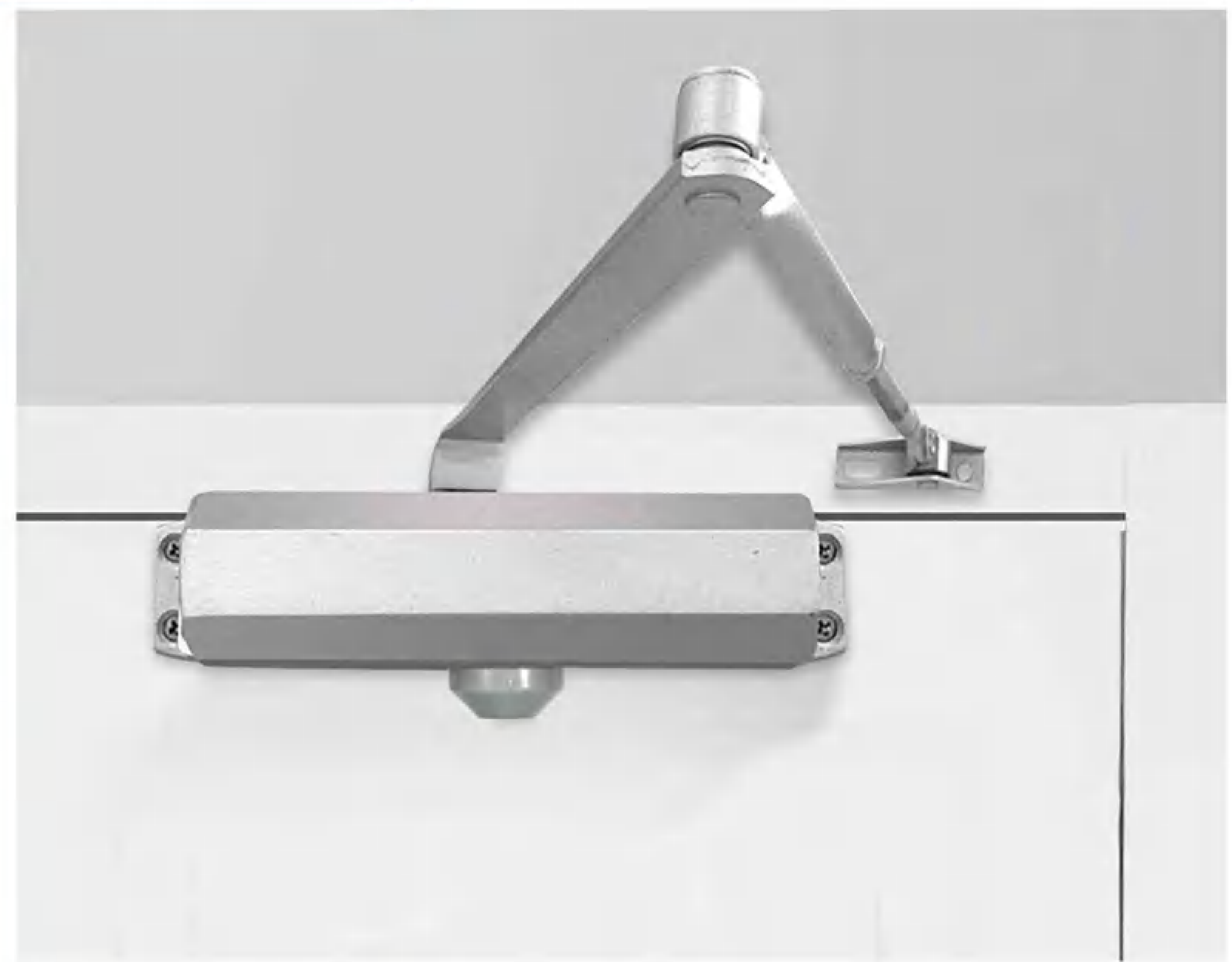

**Door Closer**











Door Closer



Sign Plates

Sign Plate



 <b>YFH-135</b>	 <b>YFH-136</b>	 <b>YFH-137</b>	 <b>YFH-138</b>
 <b>YFH-139</b>	 <b>YFH-140</b>	 <b>YFH-141</b>	 <b>YFH-142</b>

Sign Plates

Sign Plate

 <b>YFH-143</b>	 <b>YSP-001</b>	 <b>YSP-002</b>	 <b>YSP-003</b>
 <b>YSP-004</b>	 <b>YSP-005</b>	 <b>YSP-006</b>	 <b>YSP-007</b>
 <b>YSP-008</b>	 <b>YSP-009</b>	 <b>YSP-010</b>	 <b>YSP-011</b>
 <b>YSP-012</b>	 <b>YSP-013</b>	 <b>YSP-014</b>	 <b>YSP-015</b>
 <b>YSP-016</b>	 <b>YSP-017</b>	 <b>YSP-018</b>	 <b>YSP-019</b>



Sign Plates

**Sign Plate**













 <b>YSP-020</b>	 <b>YSP-021</b>	 <b>YSP-023</b>	 <b>YSP-024</b>
 <b>YSP-025</b>	 <b>YSP-026</b>	 <b>YSP-027</b>	 <b>YSP-028</b>
 <b>YSP-029</b>	 <b>YSP-030</b>	 <b>YSP-031</b>	 <b>YSP-032</b>
 <b>YSP-033</b>	 <b>YSP-034</b>	 <b>YSP-035</b>	 <b>YBC-010</b>
 <b>YBC-010-visible screws</b>	 <b>YBC-010-with legs</b>	 <b>YBC-010-3M</b>	

Door Seal

**Sign Plate**

 <b>YSP-036</b>	 <b>YSP-037</b>	 <b>YSP-038</b>	 <b>YSP-039</b>
---	---	---	---

**Door Seal**

 <b>YDBS-001</b>	 <b>YDBS-002</b>	 <b>YDBS-003</b>	 <b>YDBS-004</b>
 <b>YDBS-005</b>	 <b>YDBS-006</b>	 <b>YDBS-007</b>	 <b>YDBS-008</b>
 <b>YDBS-009</b>	 <b>YDBS-010</b>	 <b>YDBS-011</b>	 <b>YDBS-012</b>

**Gas Spring**

 <b>YAS-001</b>	 <b>YAS-002</b>	 <b>YAS-003</b>	 <b>YAS-004</b>
---	---	---	---





Door & Furniture Accessories

**Ball Catch**



**Magnetic Door Catch**



**Door Viewer**



**Dustproof Strike&Window**



**Sliding Door Roller**



Door & Window Accessories



Barn Door  
Accessories

**Barn Door Hardware**



**Barn Door Handle**

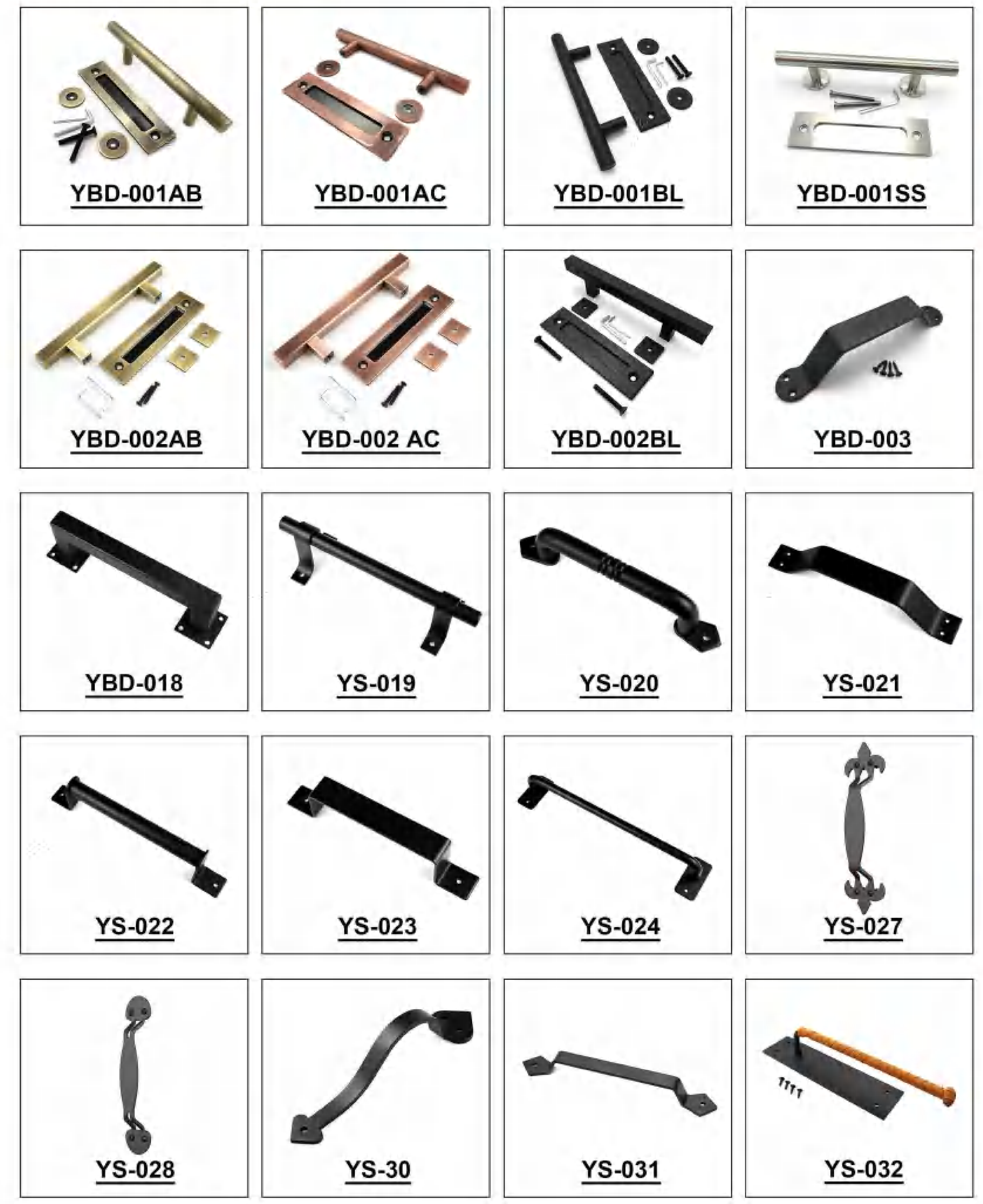

Barn Door  
Accessories



**Panic Bar**

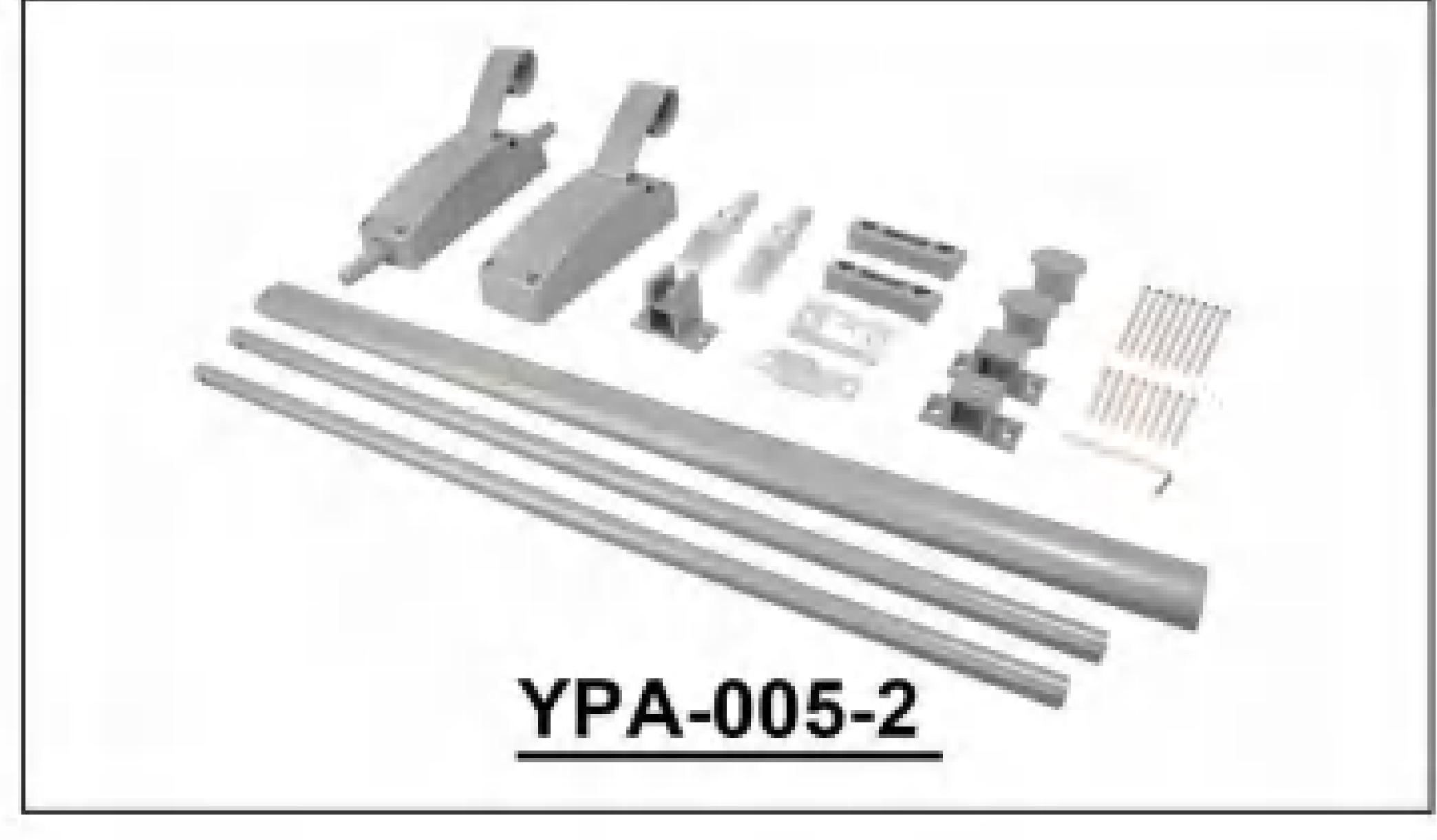









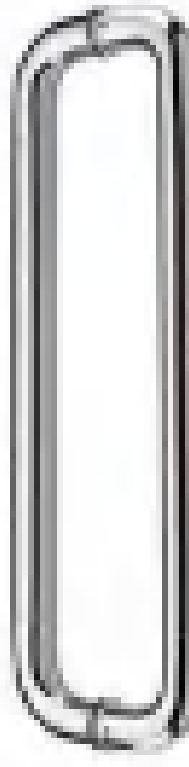

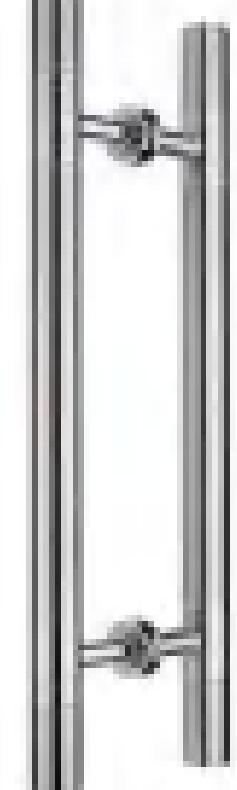

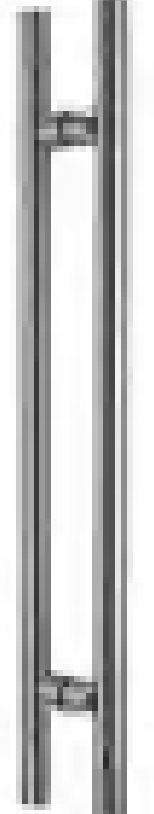
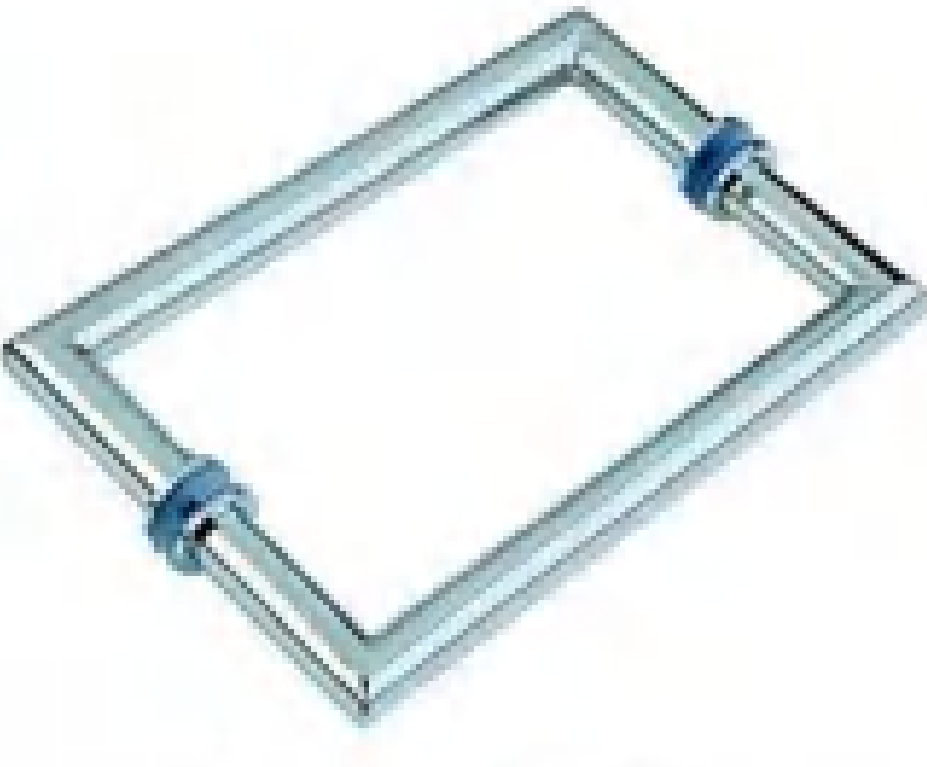
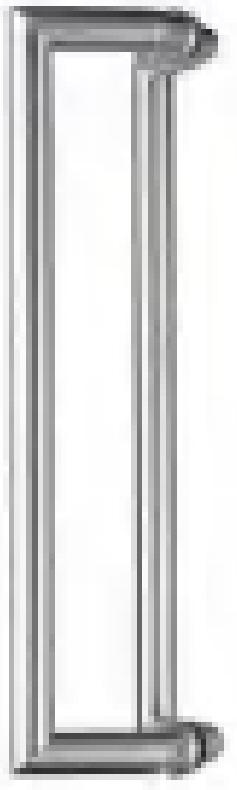
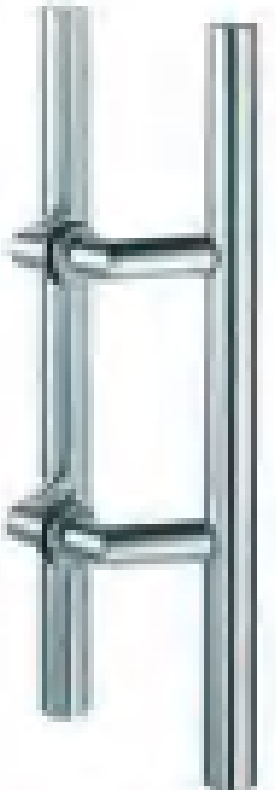
Panic Bar

Panic Bar

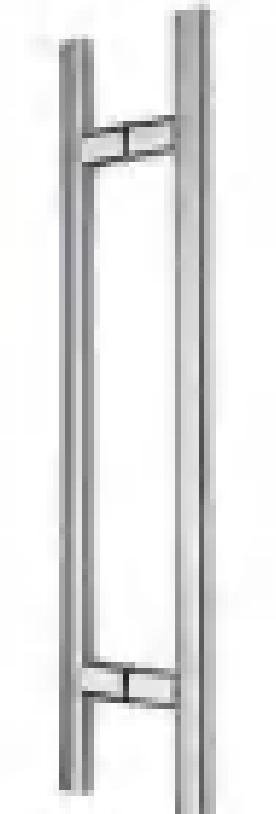
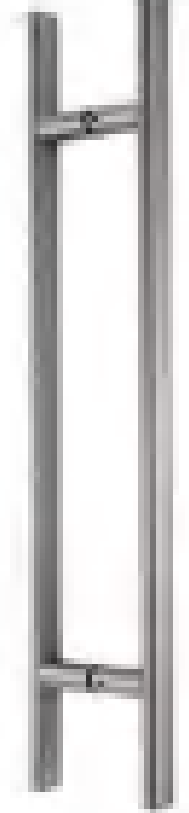
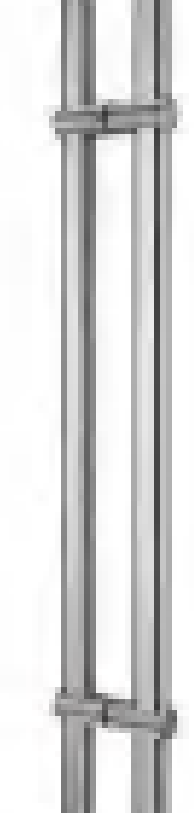
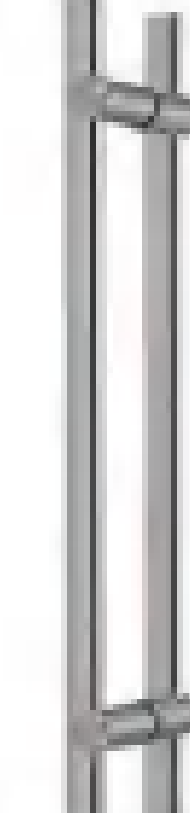
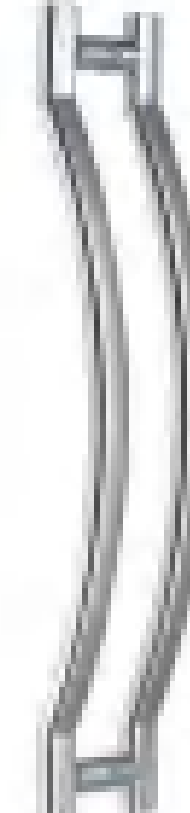

**Back-to-Back Pull Handle**

 <b>YPH-001</b>	 <b>YPH-002</b>	 <b>YPH-003</b>	 <b>YPH-004</b>
 <b>YPH-005</b>	 <b>YPH-009</b>	 <b>YPH-010</b>	 <b>YPH-015</b>
 <b>YPH-016</b>	 <b>YPH-017</b>	 <b>YPH-018</b>	 <b>YPH-019</b>
 <b>YPH-020</b>	 <b>YPH-021</b>	 <b>YPH-022</b>	 <b>YPH-023</b>
 <b>YPH-024</b>	 <b>YPH-025</b>	 <b>YPH-026</b>	 <b>YPH-027</b>

**Glass & Bathroom Accessories**



**Back-to-Back Pull Handle**



**Back-to-Back Pull Handle**



Glass & Bathroom  
Accessories

Glass & Bathroom  
Accessories



**Back-to-Back Pull Handle**



**Single Sided Handle**



**Single Sided Handle**



**Bathroom Handle**



**Handle Lock**

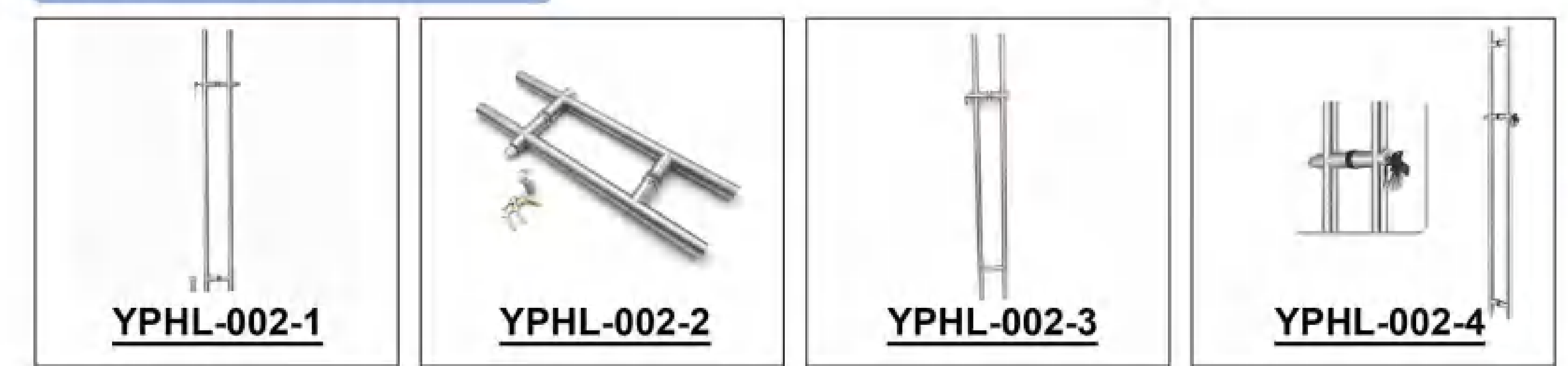

**Grab Bar**

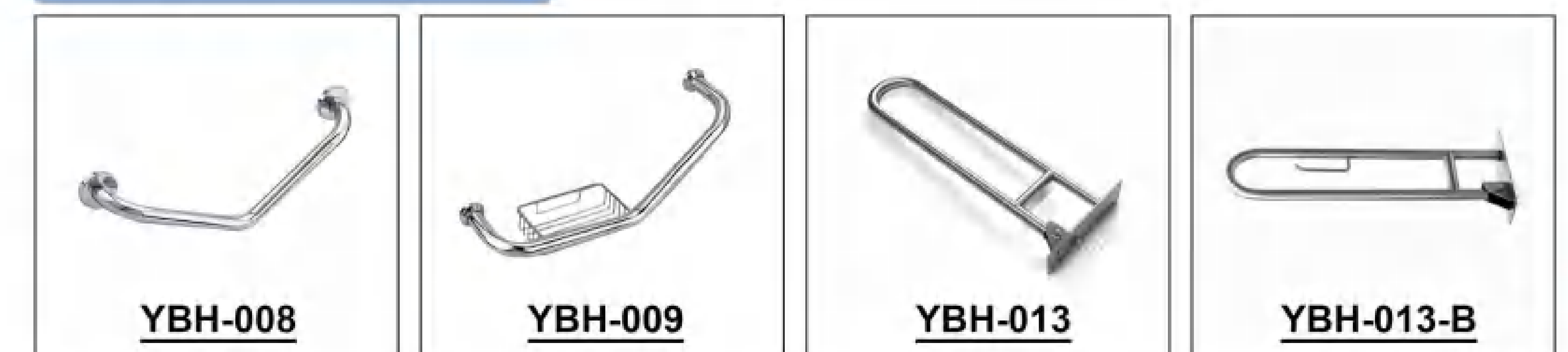

Glass & Bathroom Accessories

Glass & Bathroom Accessories





**Grab Bar**



**Shower Seat**



**Backrest**



**Shower Door Knob**





**Shower Door Knob**



**Shower Door Knob**

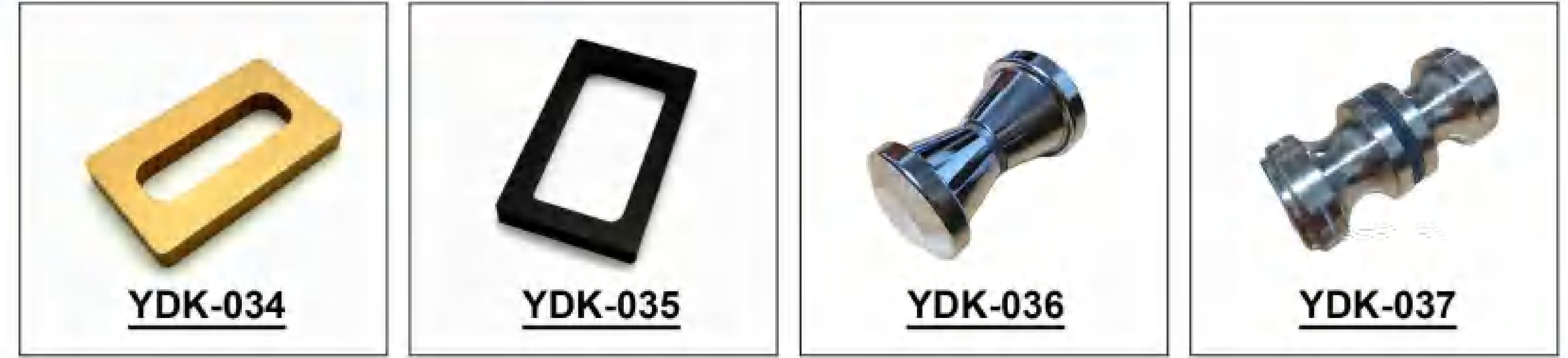

**Shower Door Hinge**



Glass & Bathroom  
Accessories

Glass & Bathroom  
Accessories



**Shower Door Hinge**



**Shower Door Hinge**



Glass & Bathroom  
Accessories

Glass & Bathroom  
Accessories





**Shower Door Hinge**

 <b>YGH-085</b>	 <b>YGH-086</b>	 <b>YGH-087</b>	 <b>YGH-088</b>
 <b>YGH-089</b>	 <b>YGH-090</b>	 <b>YGH-091</b>	 <b>YGH-092</b>
 <b>YGH-093</b>	 <b>YGH-094</b>	 <b>YGH-095</b>	 <b>YGH-096</b>
 <b>YGH-097</b>	 <b>YGH-098</b>	 <b>YGH-100</b>	 <b>YGH-101</b>
 <b>YGH-102</b>	 <b>YGH-103</b>	 <b>YGH-104</b>	 <b>YGH-105</b>

**Shower Door Hinge**

 <b>YGH-106</b>	 <b>YGH-107</b>	 <b>YGH-108</b>	 <b>YGH-109</b>
 <b>YGH-110</b>	 <b>YGH-111</b>	 <b>YGH-112</b>	 <b>YGH-113</b>
 <b>YGH-114</b>	 <b>YGH-119</b>	 <b>YGH-120</b>	 <b>YGH-121</b>
 <b>YGH-122</b>	 <b>YGH-123</b>	 <b>YGH-124</b>	 <b>YGH-125</b>
 <b>YGH-126</b>	 <b>YGH-127</b>	 <b>YGH-128</b>	 <b>YGH-129</b>

Glass & Bathroom Accessories

Glass & Bathroom Accessories



**Glass Clip**

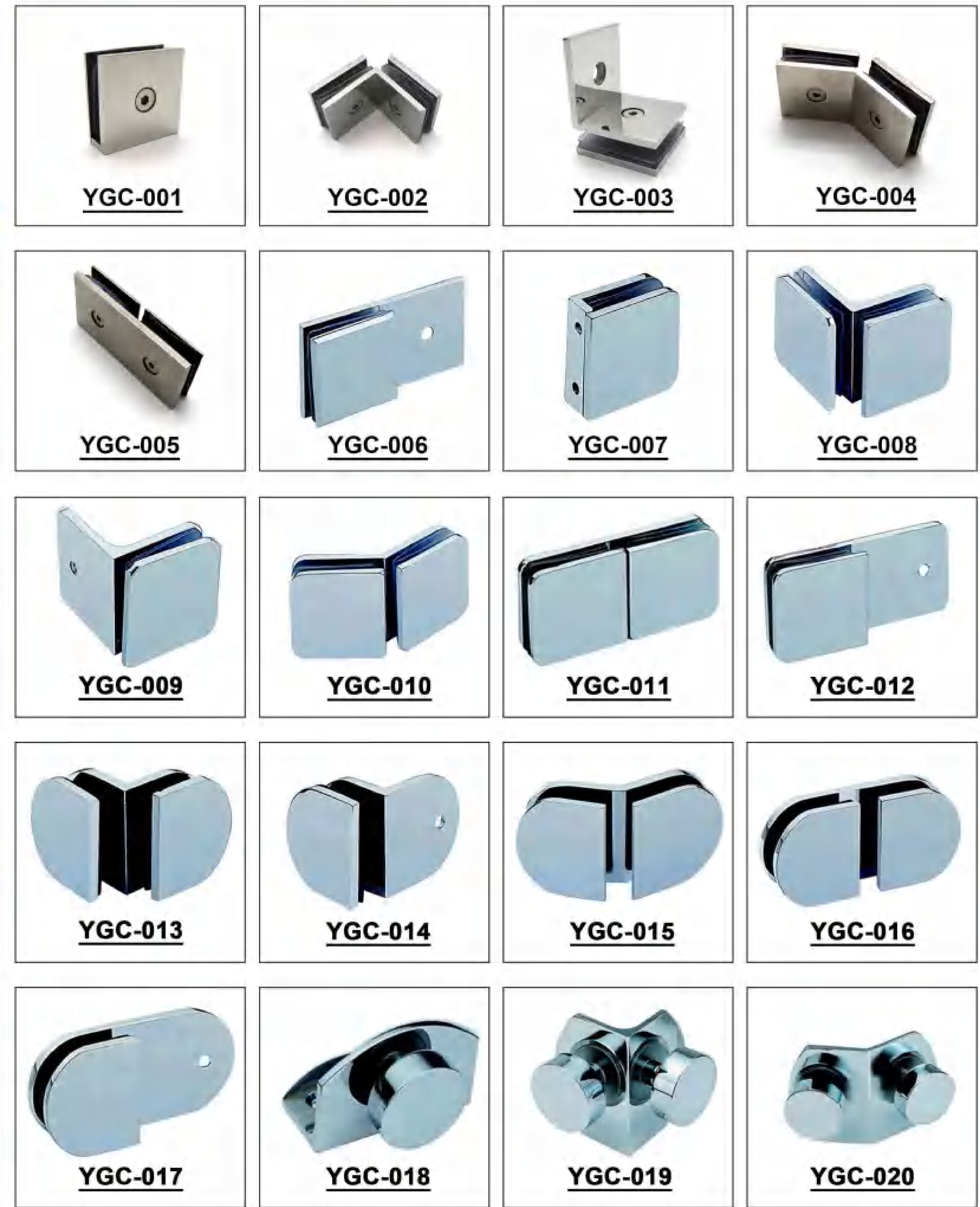

**Glass Clip**



Glass & Bathroom  
Accessories

Glass & Bathroom  
Accessories



**Glass Clip**



**Wall Bracket**



**Support Bar**



**Knight Head**



Glass & Bathroom Accessories

Glass & Bathroom Accessories



**Knight Head**



**Glass Clamp & Glass Lock**



**Glass Clamp & Glass Lock**



Glass & Bathroom Accessories

Glass & Bathroom Accessories



**Glass Clamp & Glass Lock**



**Floor Spring**



**Clothes Hook**



Glass & Bathroom Accessories

Glass & Bathroom Accessories



**Clothes Hook**

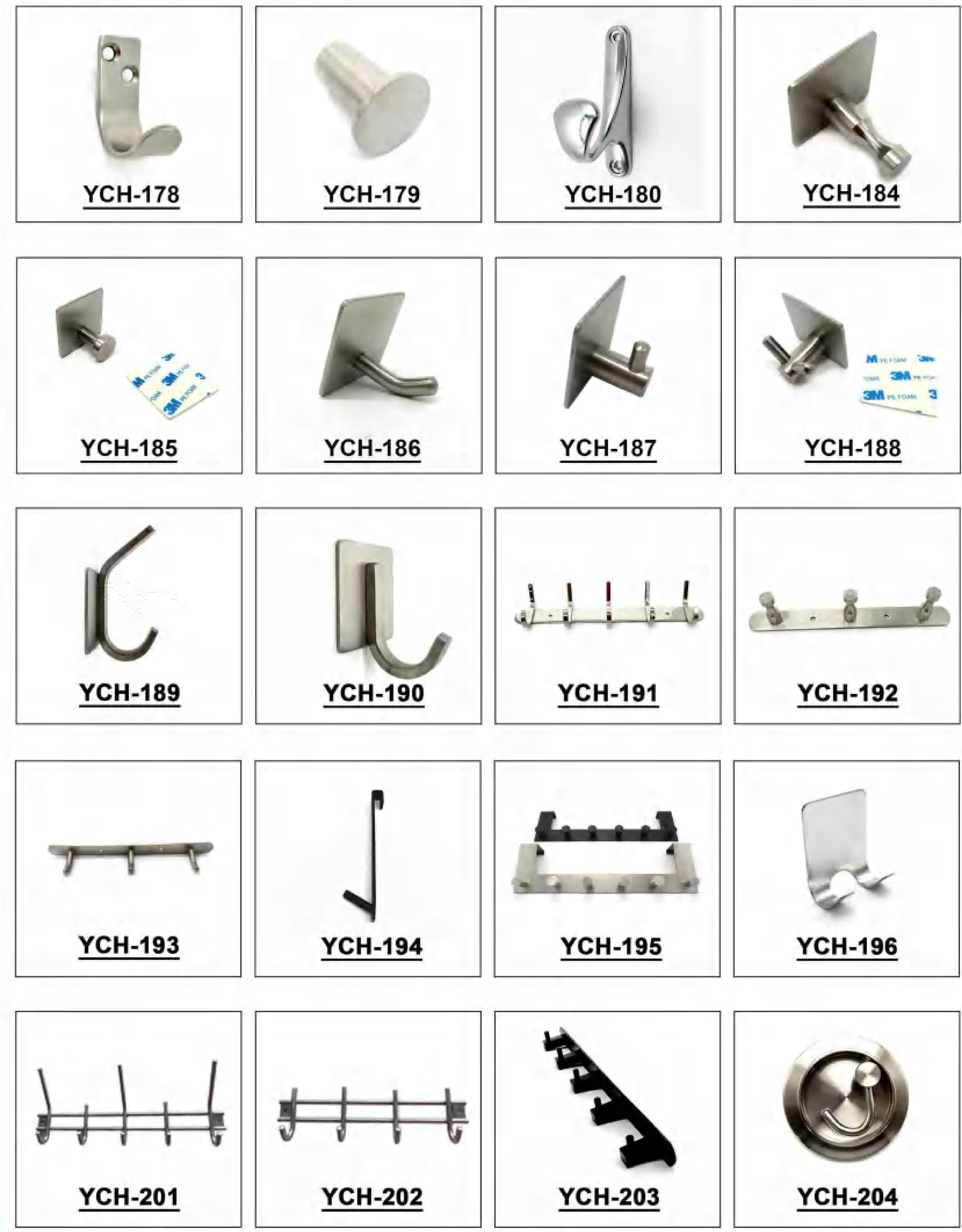

**Clothes Hook**



**Tissue Rack**



Glass & Bathroom Accessories

Glass & Bathroom Accessories



**Tissue Rack**



**Towel Rack**



**Soap Holder**



**Soap Dispenser**



**Shelf**



Glass & Bathroom Accessories

Glass & Bathroom Accessories



**Bathroom Sealing Strip**

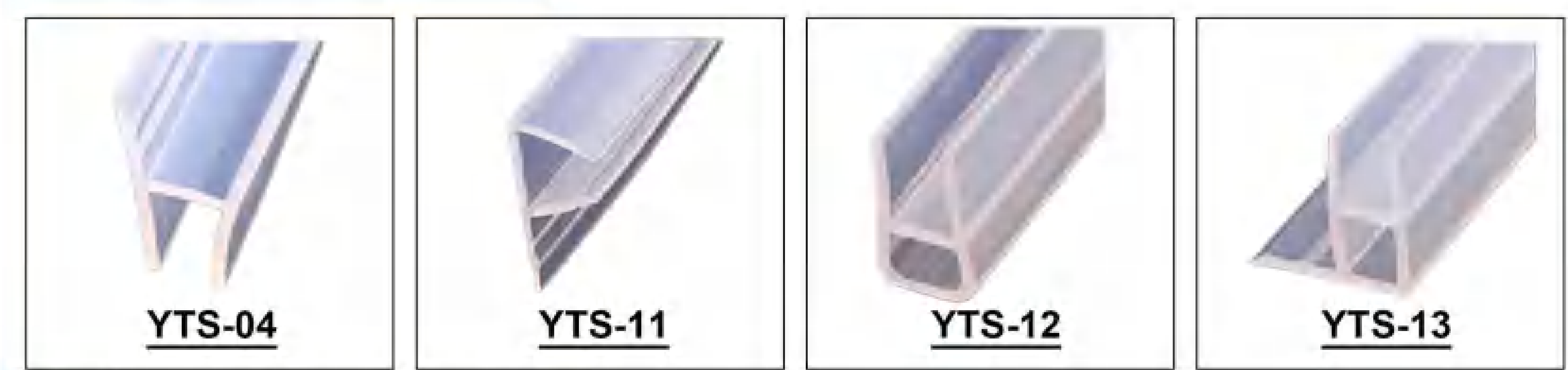

**Sliding Door Accessories**



**Sliding Door Accessories**



**Folding Door Accessories**



**Push Pull Door Accessories**

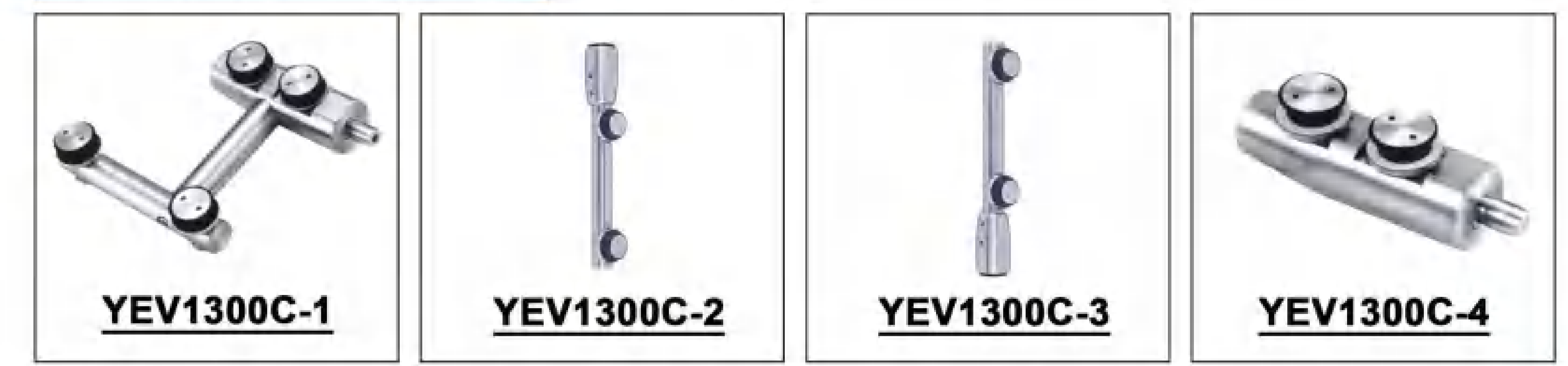

Glass & Bathroom Accessories

Glass & Bathroom Accessories



**Push Pull Door Accessories**



**Sliding Door Roller**



**Sliding Door Roller**



**Floor Drain**



Glass & Bathroom Accessories

Glass & Bathroom Accessories



**Floor Drain**



**Washroom Cubicle & Partition Fittings**



**Washroom Cubicle & Partition Fittings**



Glass & Bathroom Accessories

Glass & Bathroom Accessories



**Glass Connector**



YE V1000A-1



YE V1000A-2



YE V1000A-3



YE V1000A-4



YE V1000A-6



YE V1300E-1



YE V1300E-2



YE V1300E-3



YE V1500E-1

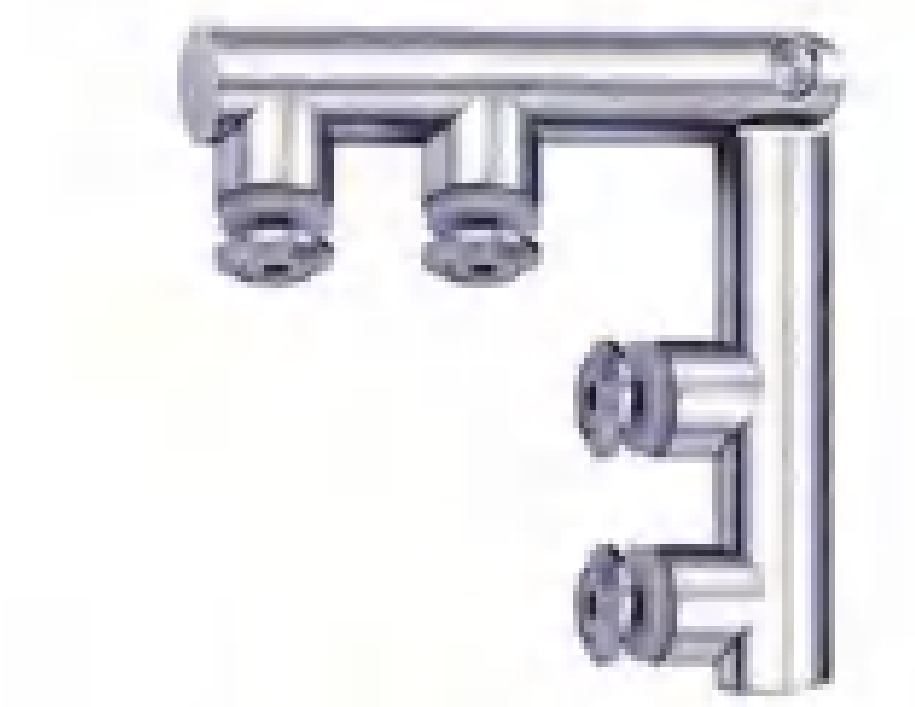

YE V1500E-2



YE V1500E-3



YE V1600E-1



YE V1600E-2



YE V1600E-3



YGB-001



YGB-002



YGB-003



YGB-004



YGB-005



YGB-005

# Glass Fixing Fittings



**Tube Connector Series**

 <u>YKA-017</u>	 <u>YKA-019</u>	 <u>YKA-020</u>	 <u>YKA-021</u>
 <u>YKA-022</u>	 <u>YKA-023</u>	 <u>YKA-024</u>	 <u>YKA-025</u>
 <u>YKA-026</u>	 <u>YKA-027</u>	 <u>YKA-028</u>	 <u>YKA-029</u>
 <u>YKA-030</u>	 <u>YKA-031</u>	 <u>YKA-032</u>	 <u>YKA-033</u>
 <u>YKA-034</u>	 <u>YKA-035</u>	 <u>YTC-001</u>	 <u>YTC-002</u>

**Tube Connector Series**

 <u>YTC-003</u>	 <u>YTC-004</u>	 <u>YTC-005</u>	 <u>YTC-006</u>
 <u>YTC-007</u>	 <u>YTC-008</u>	 <u>YTC-009</u>	 <u>YTC-010</u>
 <u>YTC-011</u>	 <u>YTC-012</u>	 <u>YTC-013</u>	 <u>YTC-014</u>
 <u>YTC-015</u>	 <u>YTC-016</u>	 <u>YTC-017</u>	 <u>YTC-018</u>
 <u>YTC-019</u>	 <u>YTC-020</u>	 <u>YTC-021</u>	 <u>YTC-022</u>

Glass Fixing Fittings

Glass Fixing Fittings



**Tube Connector Series**



**Tube Connector Series**



Glass Fixing Fittings

Glass Fixing Fittings



**Tube Connector Series**



**Bracket Series**



**Bracket Series**



Glass Fixing Fittings

Glass Fixing Fittings



**Bracket Series**



**Bracket Series**



**Glass Standoff**



**Glass Spigot**



Glass Fixing Fittings

Glass Fixing Fittings



**Glass Spigot**



**Glass Clamp**

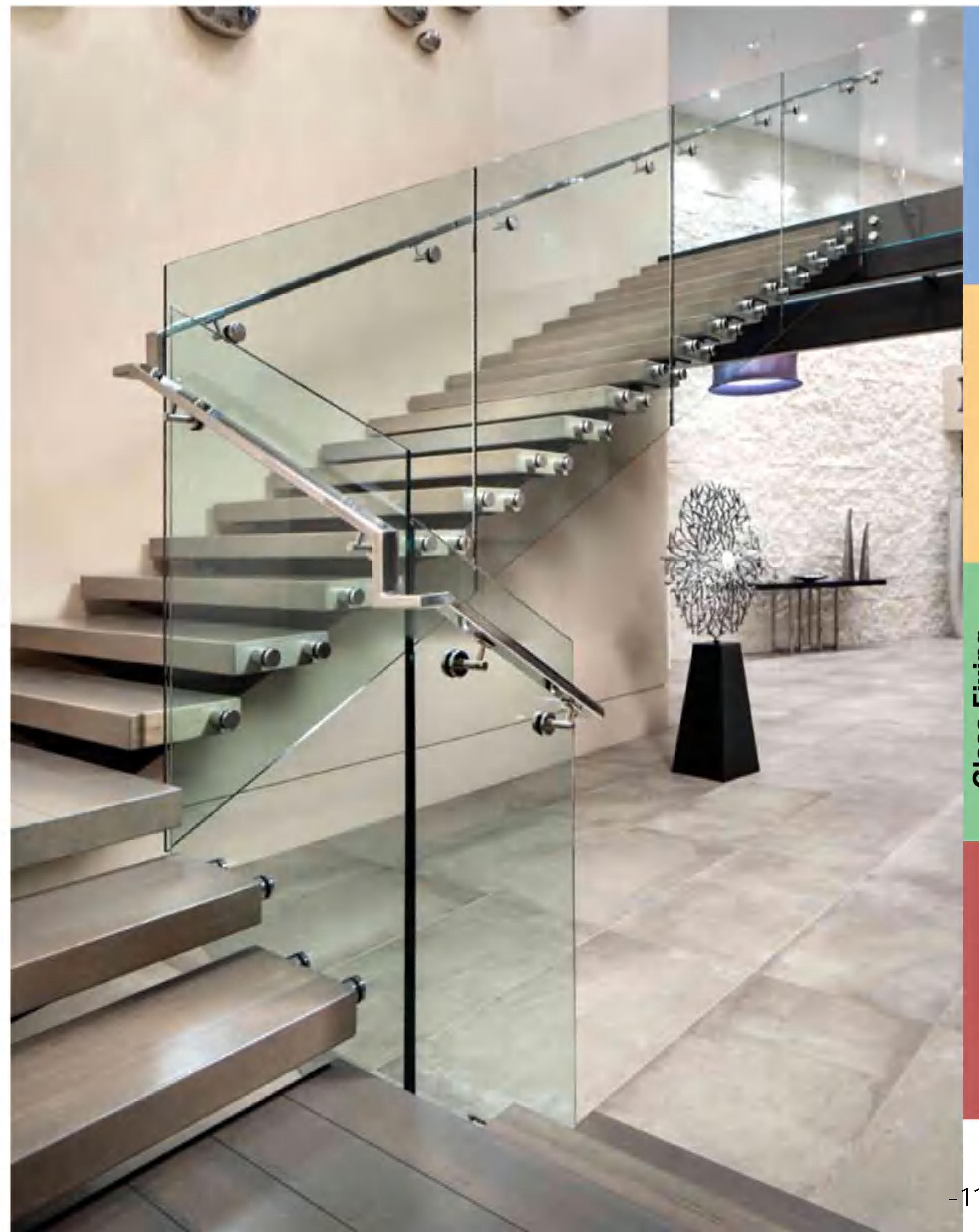

Glass Fixing Fittings

Glass Fixing Fittings





**US Mailbox**

**Ash Box**



**Stainless Steel**



**Mail Slot**



**Steel**

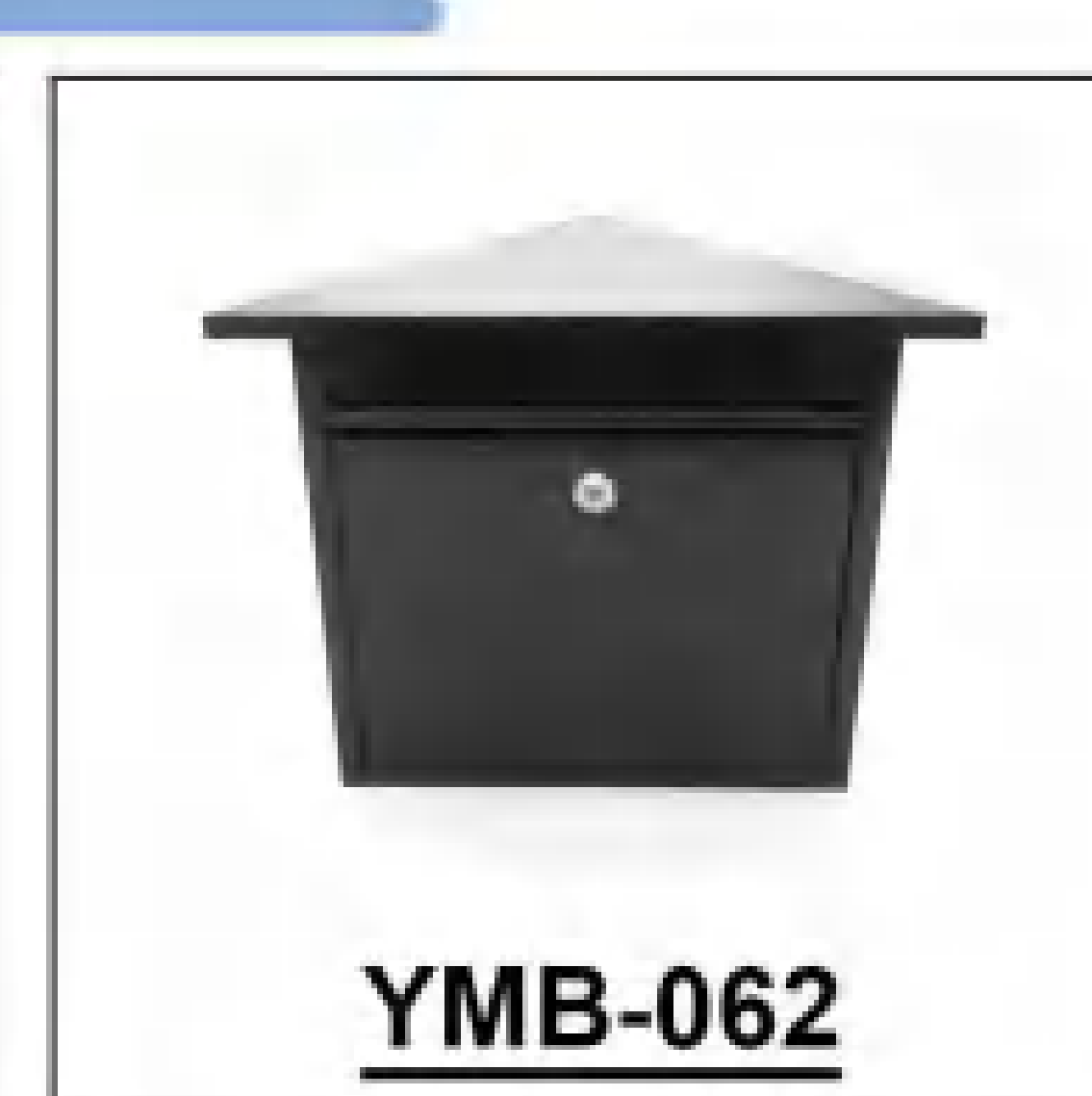

**Free Standing**



Mailbox

Mailbox



**Steel**

**Medical Box**



**Parcel Box**



**Coaster**

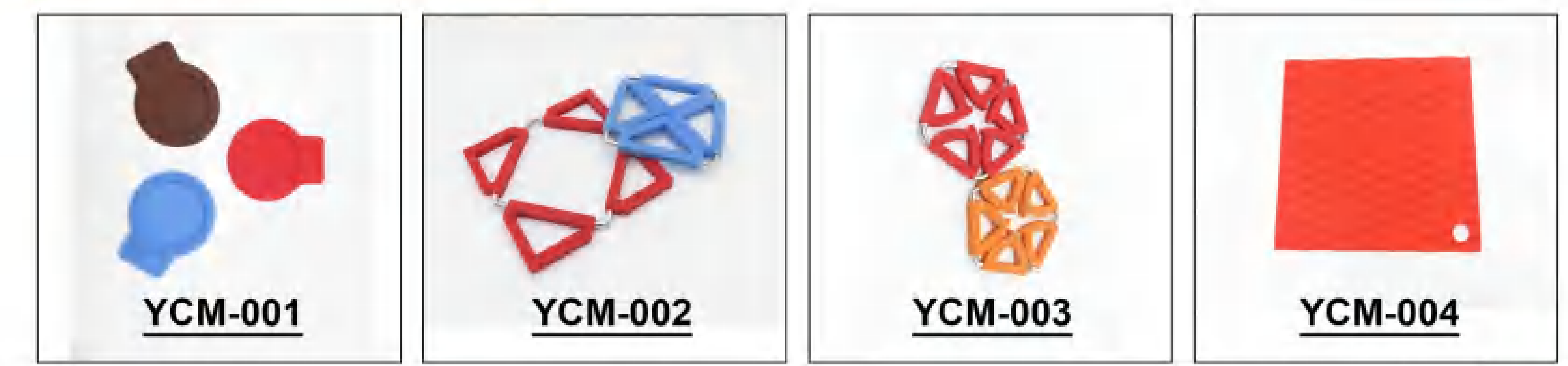

**Trash Bin**



**Barbeque Grill**



**Dish Rack**



Mailbox

Household



**Dish Rack**



**Bread Bin**



**Milk Jug & Coffee Pot**



**Kitchen Sink**



**Air Ventilation**

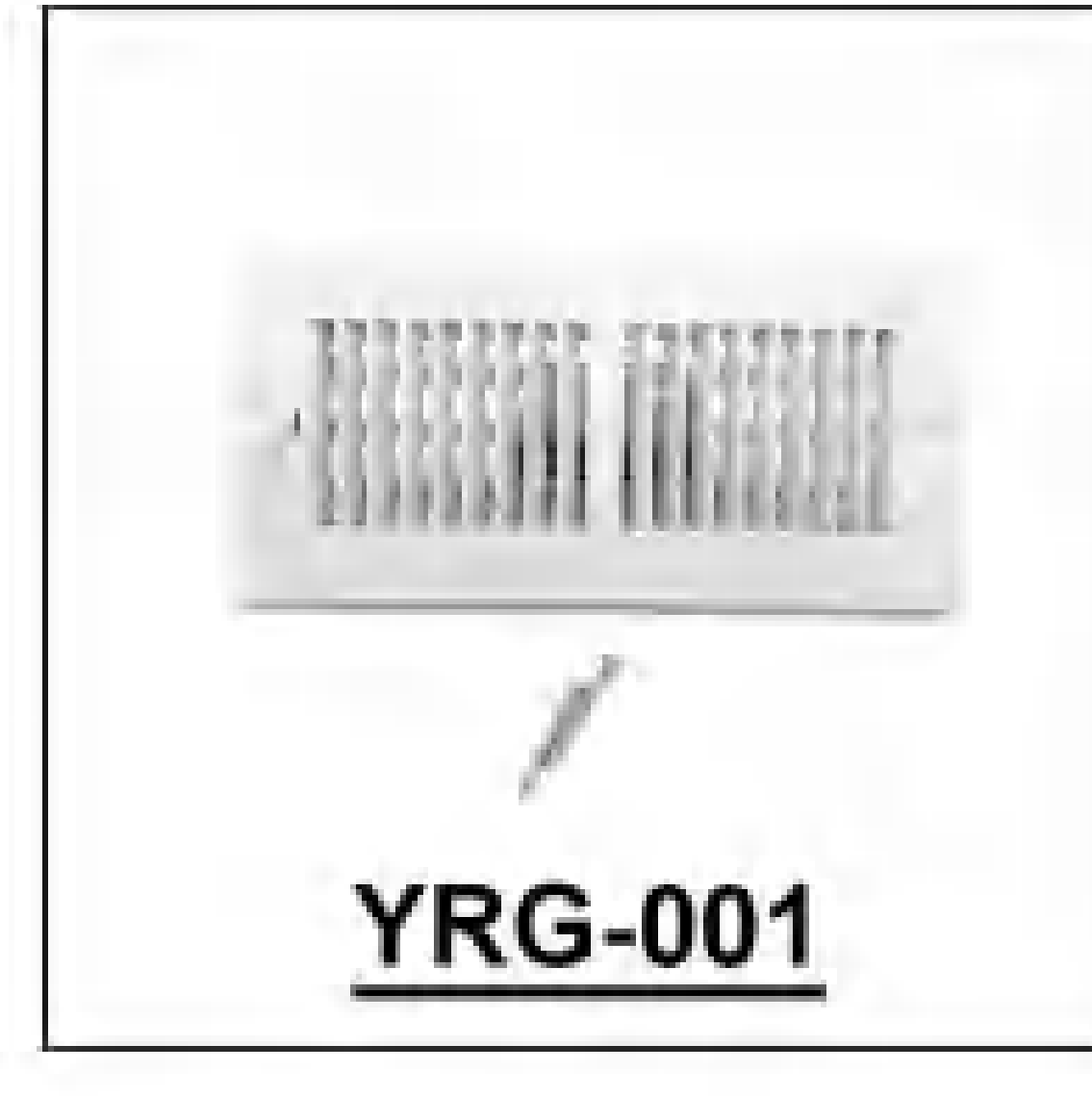
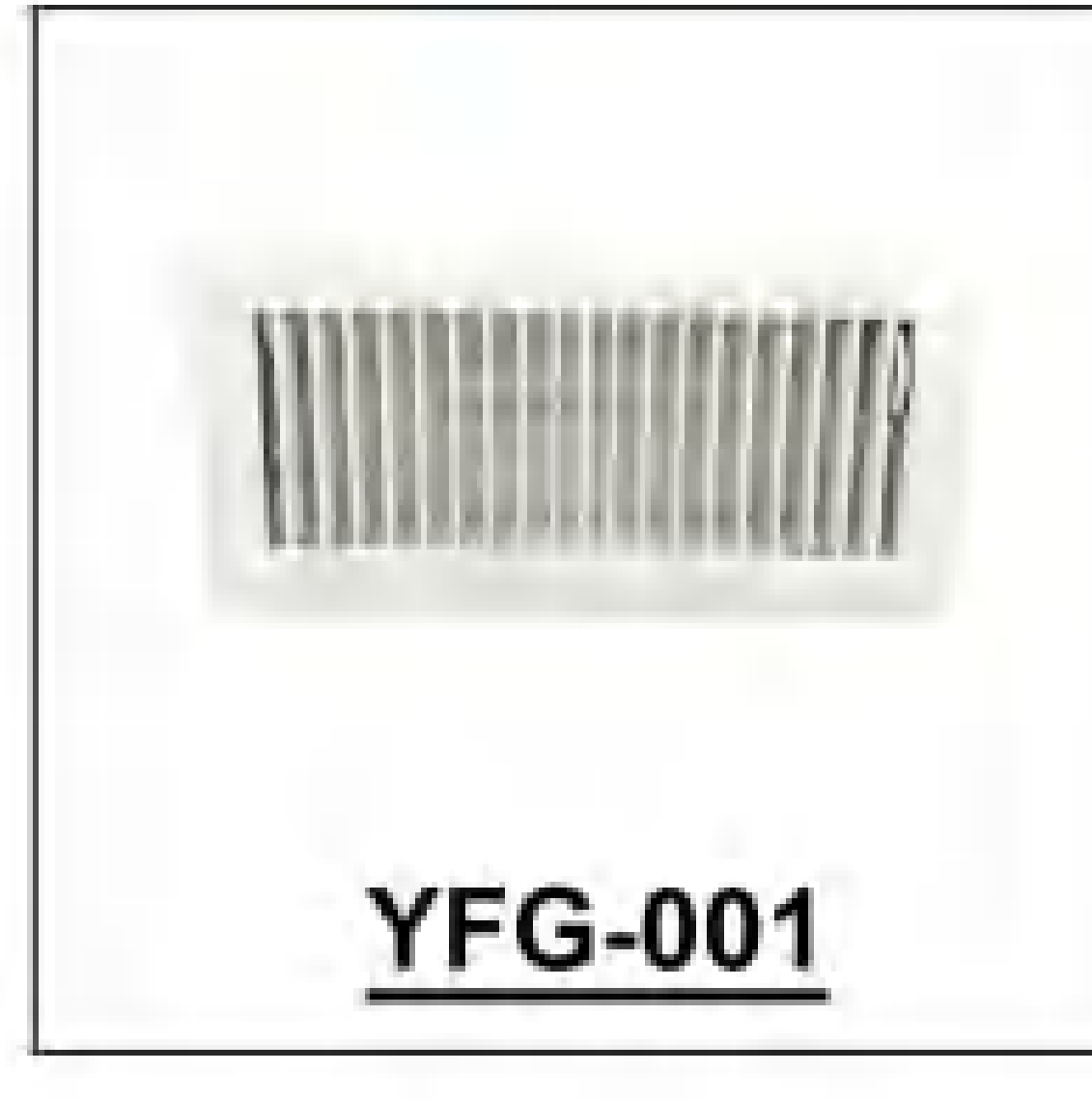

**OUR FACTORY**

Factory total building area:  
6000 square meters  
Time: Established in 2003  
Office area: 750 square meters

**OUR QUALITY**

- Superior durability and exceptional anti-rust performance
- Utilize advanced technology for extended lifespan
- Offer a wide range of surface treatments customized to meet customer requirements
- Customized products to cater to diverse market demands
- Expert quality control, trustworthy business practices, and dedicated after-sales service



**OUR MARKET**

We are proud of our successful export markets in Europe, Northern and Southern America, Oceania, Middle East and Southeast Asia.



**WHY  
CHOOSE  
US**