

LTS-3LINH300

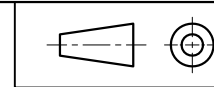

产品型号	LTS-3LINH300
LED发光色	R(红)/W(白)
输入电压	DC 24V (max)
消耗功率	/
电缆极性	1:LED+, 2:LED-, 3:FAN+, 4:FAN-

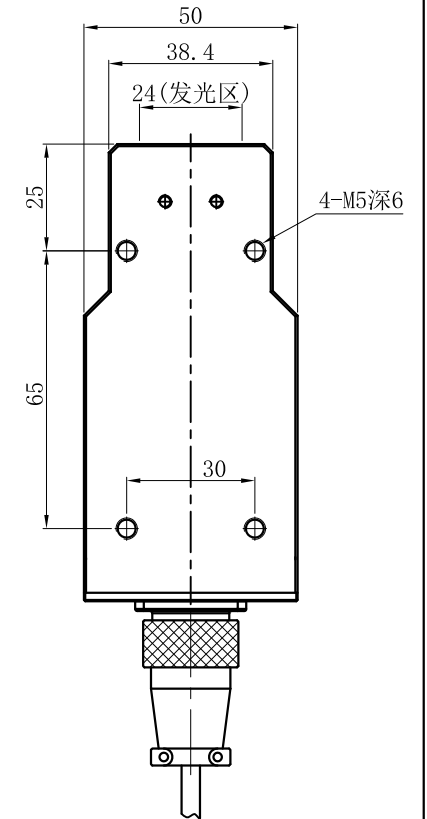
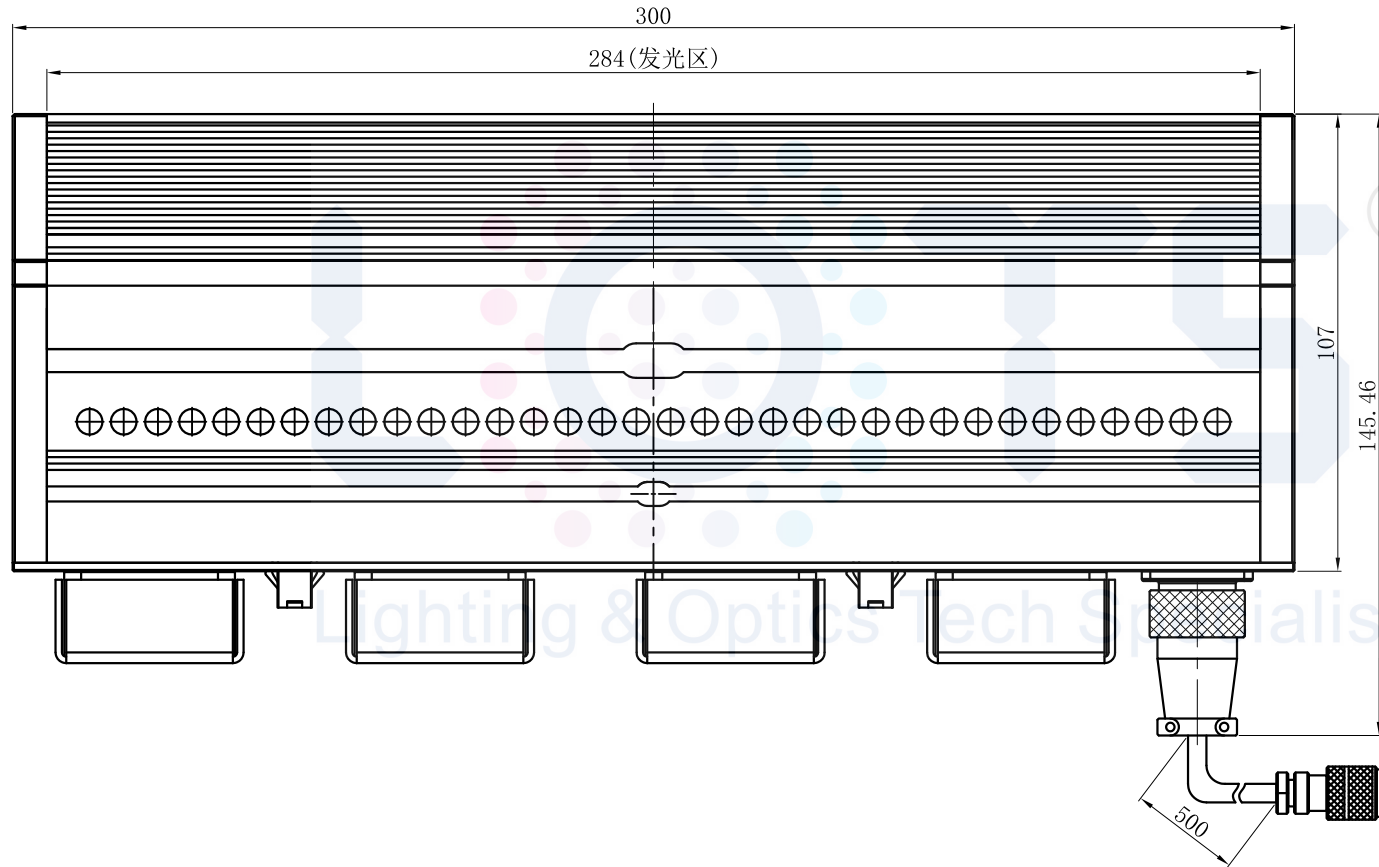

注: 两侧有M3和M5的螺母卡槽
用于安装。