

LTS-4LINS400

		产品型号	LTS-4LINS400
		LED发光色	R(红)/W(白)
单位	mm (毫米)	输入电压	DC 24V(max)
比例	1:1	消耗功率	/
版本	NO 2.0	电缆极性	1:+、2:-、3:FAN+、4:FAN-

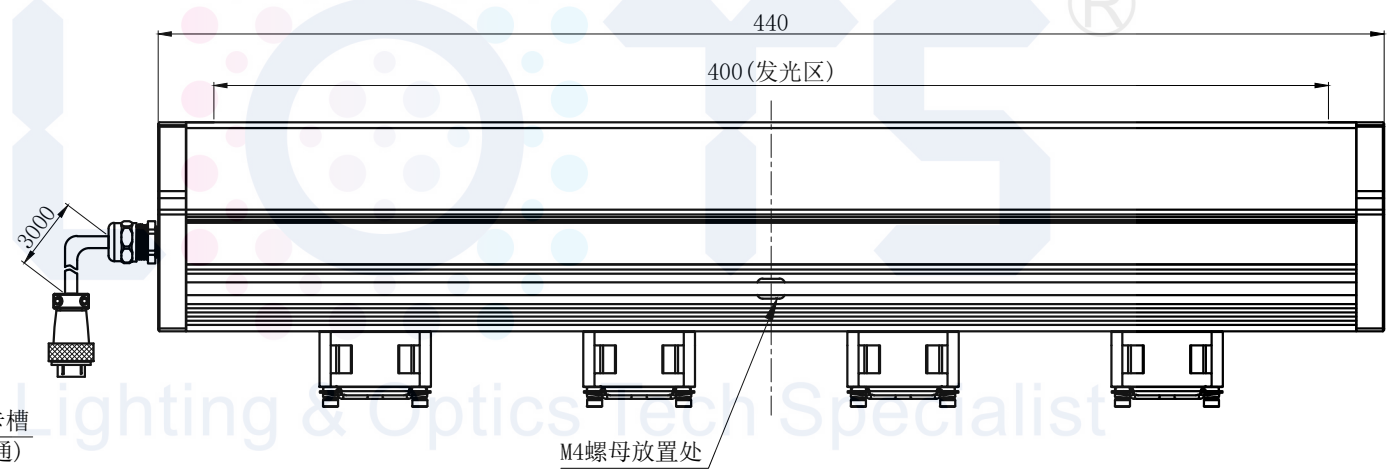
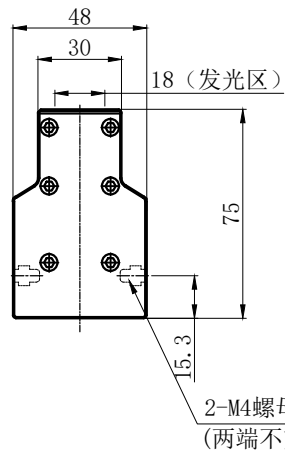
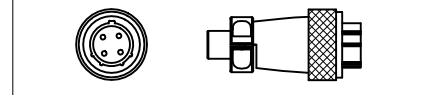

注:四周有M4的螺母卡槽用于安装。