

USER MANUAL

CAUTION

- 1) BE SURE THE ELECTRICITY TO THE WIRES YOU ARE WORKING ON IS SHUT OFF; EITHER THE FUSE IS REMOVED OR THE CIRCUIT BREAKER IS TURNED OFF. TURNING THE POWER OFF USING THE LIGHT SWITCH IS NOT SUFFICIENT TO PREVENT ELECTRICAL SHOCK.
- 2) DO NOT INSTALL OR USE THE LIGHT FIXTURE IF ANY PART IS MISSING OR DAMAGED. CONTACT YOUR DEALER FOR REPLACEMENT OR MISSING PARTS.
- 3) TO PROTECT THE FINISH, DO NOT USE CLEANSERS OR ABRASIVES DURING MAINTENANCE.
- 4) TO AVOID POSSIBLE FIRE OR ELECTRICAL SHOCK, MAKE SURE NO BARE WIRE STRANDS ARE EXPOSED OUTSIDE WIRE CONNECTORS.



INSTALLATION

If there is junction box in the wall, please follow below steps:

a) connect the wall plate with the mount bracket.

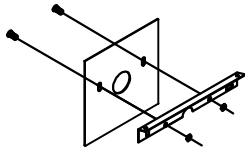

b) install the mount bracket onto the wall, make sure the wall plate can cover the junction box in the wall.

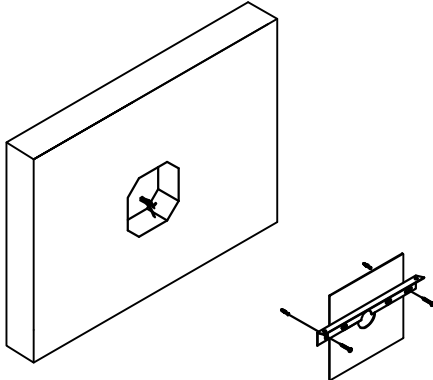

c) electric connection, black wire is live wire, white wire is neutral wire, yellowgreen wire is grounding wire.

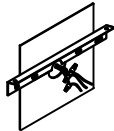

d) install the light fixture onto the mount bracket.

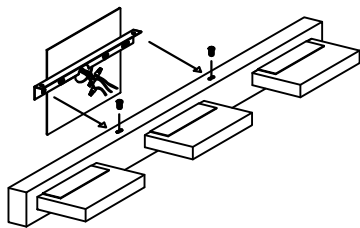

If there is NO junction box in the wall, please follow below steps:

a) install the mount bracket onto the wall.

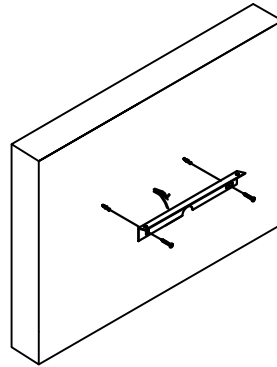

b) electric connection, black wire is live wire, white wire is neutral wire, yellowgreen wire is grounding wire.



c) install the light fixture onto the mount bracket.

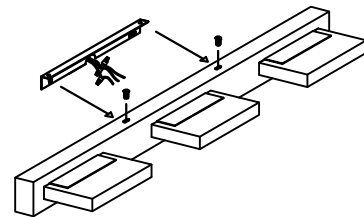

CAUTION

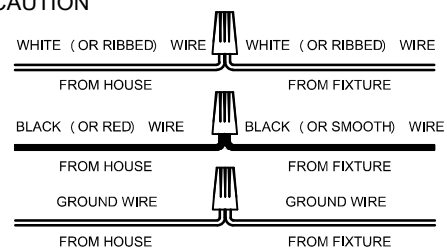

COMPONENT LIST

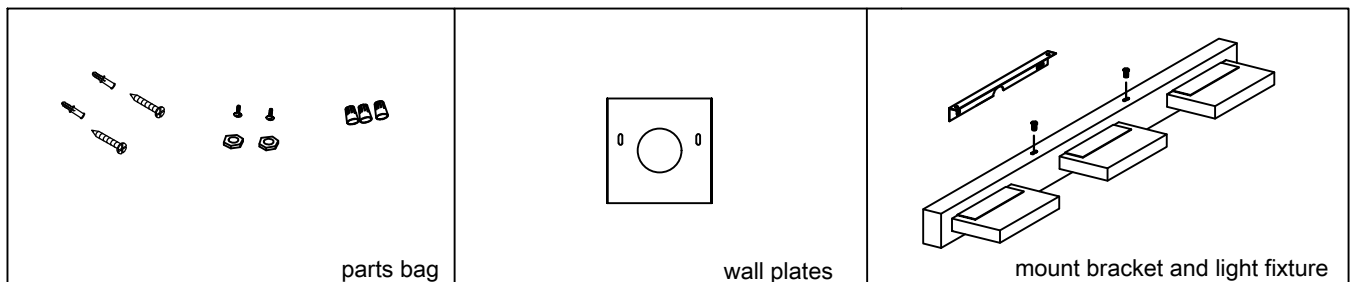

SPECIFICATION

Input Voltage: 110~120V 50/60Hz
 Wattage: 16w CCT: □ 3000K □ 5000K CRI: >80
 Product Size: Height 1.97in (50mm) / Width 18.11in (460mm) / Depth 4.06in (103mm)

Thank you for shopping with us, please feel free to contact us if you have any issue on product installation or application. Please save this user manual as purchase proof and future reference.

www.mirrea.com

mirrea®